

## Reference Material

# Mark 3 OHW Tunnel Cantilever – Reference document in support of ASA General arrangement drawing EL03571

*This document is published as reference material. The content described might be of assistance to individuals and organisations performing work on Transport for NSW Rail Assets.*

*This document is third party material and is published in good faith, with permission from Sydney Trains.*

*This document describes the Mk-3 Tunnel Cantilever, outlining its development, functionality, design limitations, installation guidelines, and installation quality checks.*

Authorised by: Lead Electrical Engineer, Asset Standards Authority

Published: 18 July 2014

### Important Warning

If this document forms part of a contract with, or is a condition of approval by, a NSW Government agency, use of the document is subject to the terms of the contract or approval.

This document may not be current. Current standards are available for download from the Asset Standards Authority website at [www.asa.transport.nsw.gov.au](http://www.asa.transport.nsw.gov.au).

# The New “Mark-3” OHW Tunnel Cantilever

By Ken FitzGerald

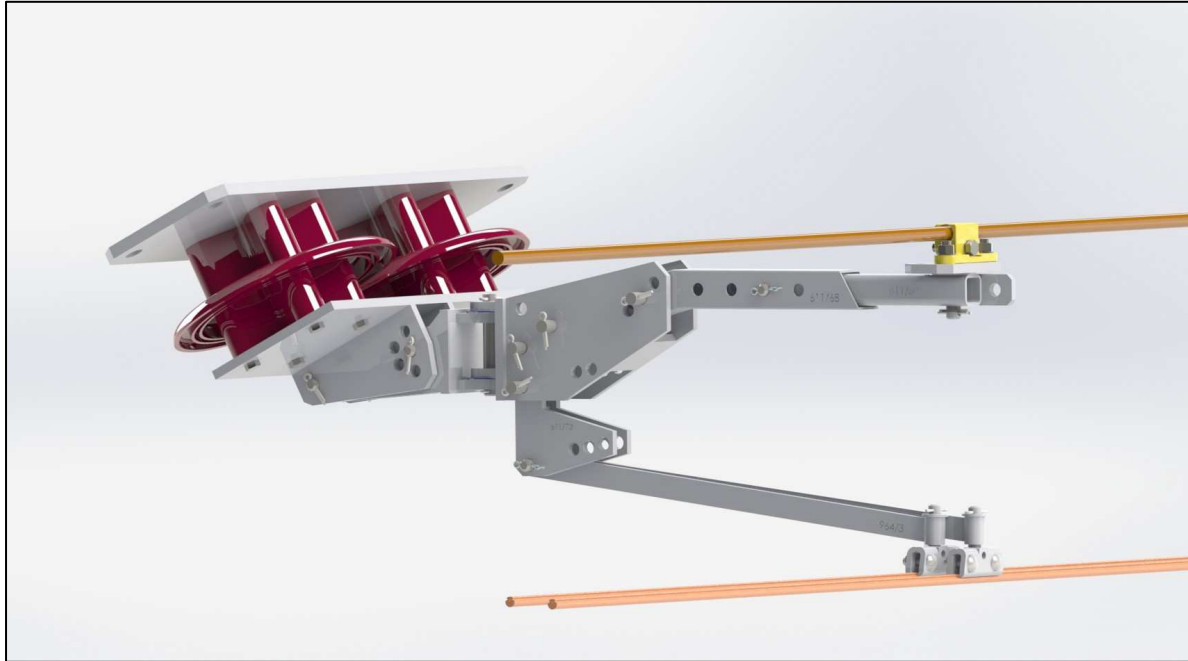

## Table of Contents

1. Introduction	3
2. General Description	4
3. Main Features	6
4. Design Development of the Mk-3 Tunnel Cantilever	8
5. Configuration of the Mk-3 Tunnel Cantilever	10
6. Adjustability Provisions	15
6.1. Insulator Support Orientation Against Tunnel Lining	16
6.2. Catenary Height Adjustment	17
6.3. Catenary Stagger Adjustment	18
6.4. Contact Stagger Adjustment	19
6.5. System Depth & Heel Height Adjustment	20
6.6. Contact Uplift Limiter	24
7. Design Aspects	26
7.1. How the Cantilever Works	26
7.2. Limitations & Reasons	31
7.3. Strength Checks	36

8. Installation Guide	37
8.1. Location of Tunnel Bracket	37
8.2. Parts “A” & “B”	37
8.3. Installation Sequence	38
8.4. Adjustments	41
a) Effect of changing Catenary Height on Contact Height and Heel Height.	41
9. Integrated Support Requirements	43
9.1. Maintenance Requirements	43
a) Maintenance Requirements Analysis (MRA)	43
b) Service Schedules	43
c) Technical Maintenance Plan	43
9.2. Spares Support	43
9.3. Operations & Maintenance Manuals	44
9.4. Training	44
9.5. Support Equipment & Tooling	44
10. Risks	45
11. Quality Assurance Inspections & Handover	47
12. Conclusion	49
Appendix “A” - Tunnel Cantilever Standard Arrangement Drawing	51
Appendix “B” - North Sydney - Up Shore Cross-Sections With Tunnel Cantilever	53
Appendix “C” - Civil Anchor Bolts for Tunnel Cantilever	56
Appendix “D” - OHW Design Drawings Calling Up Tunnel Cantilever	58
Appendix “E” - Maintenance Requirements Analysis	61
Appendix “F” - Service Schedules	72
Appendix “G” - Technical Maintenance Plan	73
Appendix “H” - OHW Conductor Movement / Temperature Chart	74

## 1. Introduction

A new Tunnel Cantilever was developed in 2012 to support regulated OHW at North Sydney in the 4 single track tunnels (which have minimal headroom for any equipment). See *Figure 1*.

The existing 80 year old OHW is supported by simple Fixed-Anchored equipment. However, the need for the new Regulated Twin Contact OHW system required a different arrangement to be developed – one that could not only support the weight of the wire and register the radial loads of both Catenary and Contact wires, but also could accommodate the necessary longitudinal wire movement that accompanies changes in wire temperature in a Regulated system, and all this in a very small space.

This document describes the new Mk-3 Tunnel Cantilever, outlining :

- Why it was developed,
- Its functionality & adjustability,
- Necessary design limitations,
- Installation guidelines, and
- The necessary quality checks when installed.

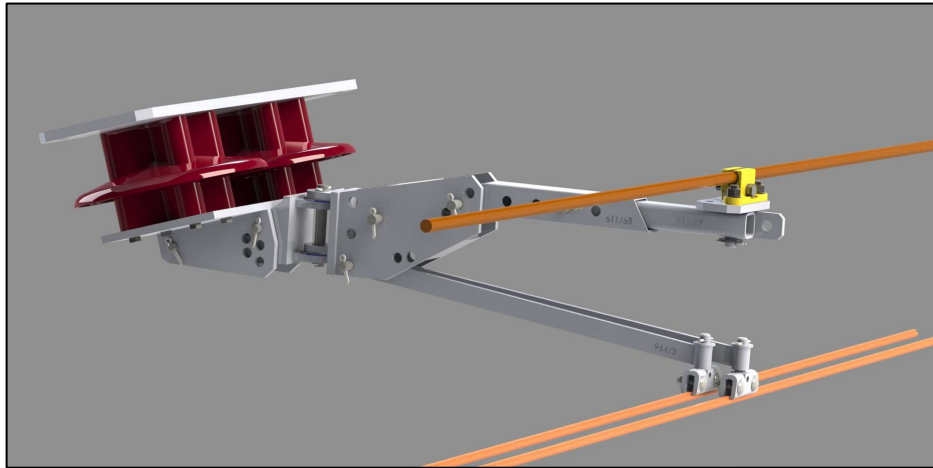

Figure 1 - CAD View of Mark-3 Tunnel Cantilever without Heel Adjuster



## 2. General Description

Because of the restricted headroom typically available in a single-track “bread-loaf” shaped tunnel, this Mk-3 Tunnel Cantilever has been designed as a compact unit to support the Catenary wire and register both Catenary and Contact wires, taking into account the tunnel lining shape and clearances, and the track’s relative position. It allows both sets of wires to move longitudinally (in the direction along the track) as the Regulated OHW system demands.

The big driver for this new arrangement was the reluctance to cut deep pockets into the tunnel lining to :

- mount a pull-off arrangement (typically this would include a post type insulator and longer pull-off arms), and
- probably also mount some catenary support arrangement (post type insulator or the like for regulated OHW).

This reluctance came about because of the relatively poor quality of the concrete in the tunnel lining at North Sydney (built in the early 1930’s), the extreme difficulty anticipated in cutting such a deep pocket, suitably sealing the cavity from moisture egress, reduced structural integrity of the tunnel lining, etc. The single track tunnels at North Sydney consist of the tunnel lining (which is about 100mm thick), then a cavity (of variable depth), then the bedrock. Suffice to say that cutting pockets would be very expensive, and may leave some uncertainty as to the final security of the OHW equipment (in the long term).

Refer to *Figure 2* for an example of how deep some pockets needed to be in the past for registering OHW conductors. This example was at Waverton, only about 1km further north from where the Mk-3 Tunnel Cantilevers are proposed at North Sydney.

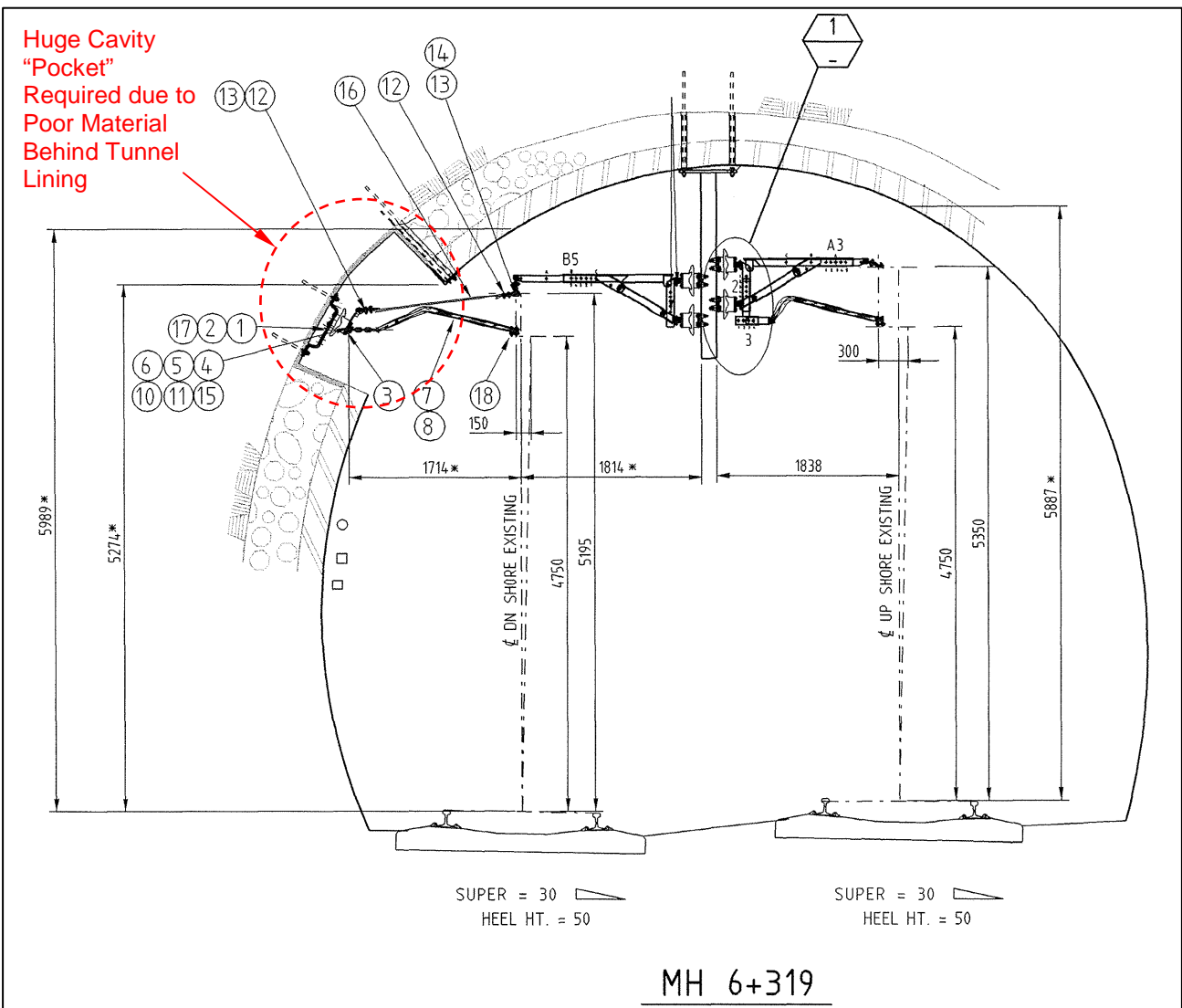

Figure 2 - Example of Alternative Deep Pockets Cut Into Tunnel Lining for OHW Registration

The pockets needed to be cut back to a depth of 800mm to reach bedrock (because behind the tunnel lining was a significant depth of loose rocks which were unsuitable for anchoring). Unfortunately this made for a huge cavity which took quite a while to establish and required quite a lot of engineering design thinking for solutions.

A far better outcome (especially from the Civil Design perspective) would be to mount a simple plate onto the tunnel lining (instead of the deep pockets) – thus the need for the new Tunnel Cantilever.

In this situation at North Sydney, 4 long anchor bolts are used for securing the mounting plate to the tunnel lining - these were required to be about 1,200mm long so as to anchor into the bedrock (using epoxy resin for the fastening to this bedrock). Another 2 shorter anchor bolts anchor the plate to the lining to prevent any localised movement of the plate.

Of course, the most important aspect in the OHW is the Contact height and stagger, as this has a direct bearing on the interface with the train's pantographs (ie. "Pantograph Security").

The new arrangement basically consists of :

- A pair of standard cycloaliphatic resin insulators (Fitting 452/10), mounted onto the tunnel lining, and providing the necessary 1500V insulation and mechanical strength to support the rest of the cantilever.
- A main frame, which pivots at one end using a vertical pin and allows the OHW conductors to move longitudinally with wire temperature changes.
- A Catenary support tube arrangement, which allows the Catenary wire to be supported and registered laterally at the required spatial position (using telescoping tubes and 16mm pin adjustment). The Catenary support itself is on a swivel plate that allows the longitudinal wire movement to take place whilst avoiding fatigue on the Catenary wire.
- A Contact registration arrangement, using discrete length arms (in 50mm increments).
- If necessary, a "Heel Adjuster" can be added to the main frame to lower the connection of the pull-off arms to gain a lower Heel height or allow for a greater System Depth (vertical distance from Catenary to Contact). See *Figure 3*.

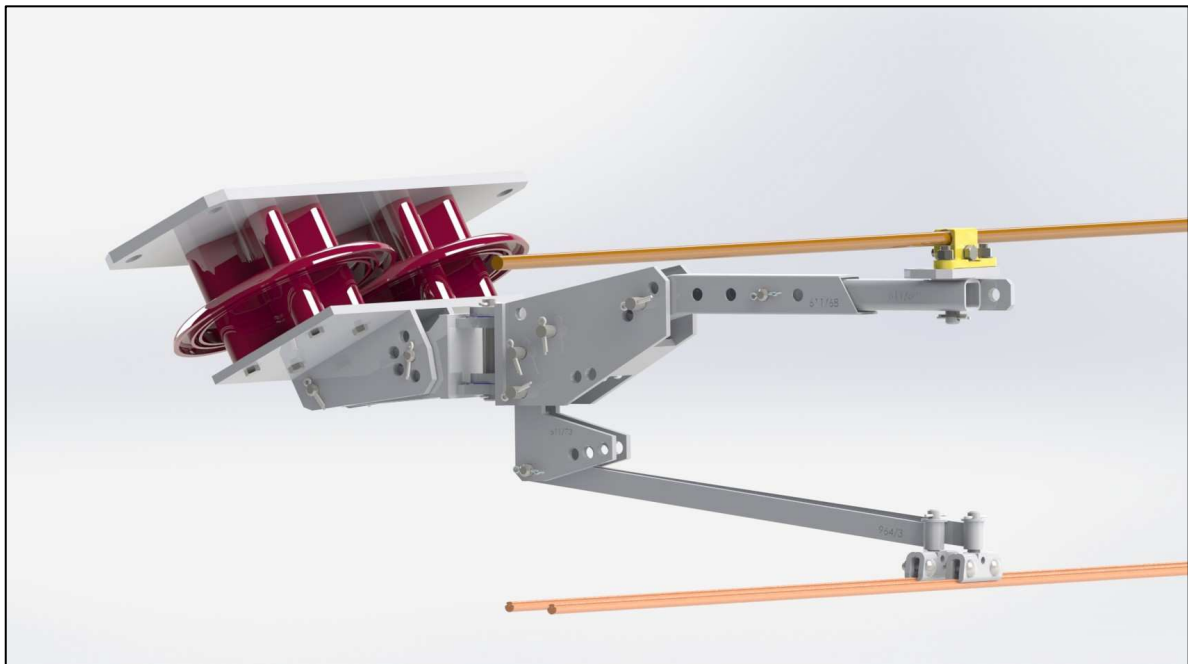

**Figure 3 - CAD View of Mark-3 Tunnel Cantilever with Heel Adjuster**

The arrangement configuration allows for the following OHW conductor configurations. However the standard arrangement drawing only approves the case of the 2nd configuration below :

- Single Catenary / Single Contact,
- Single Catenary / Twin Contact - the "Standard" OHW system "2" (270mm<sup>2</sup> Catenary / 2x137mm<sup>2</sup> Contacts), which is used at North Sydney, and
- Twin Catenary / Twin Contact.

### 3. Main Features

The main features that were promoted during the design development of the new Mk-3 Tunnel Cantilever are:

- a) Compact arrangement. Consistent with the available space in a single track “bread loaf”-shaped tunnel.
- b) Adjustability. The placement of 17mm diameter holes for insertion of the standard 16mm diameter stainless steel pins provide :
  - Incremental rotational adjustment of 5°(with maximum error of 2.5°), and
  - Discrete height and lateral adjustment in standard 50mm increments (resulting in a maximum error of ±25mm).
- c) Maximised System Depth. This is desirable as it results in longer dropper lengths for each bay of droppers, thus minimising the number of “Short” droppers (which are not adjustable and can cause problems in case of unforeseen Contact height problems).
- d) Use of Standardised Parts (minimising additional parts). Where practical, standard OHW parts including 16mm stainless steel pins, Catenary bridge clamps, post-type insulators and Contact swivel clamps were all used to minimise additional inventory.



Figure 4 - Installed Mk-3 Tunnel Cantilever at North Sydney (Up Shore Track)





Figure 5 - Lateral View of Mk-3 Tunnel Cantilever

Reference material - for information only

## 4. Design Development of the Mk-3 Tunnel Cantilever

It is important to understand the main parts of the Mk-3 Tunnel Cantilever, and how they come together to provide their various roles, including that of adjustability. For this, reference is made to the standard arrangement drawing EL 0357173 (in Appendix “A”).

While a suitable placement of the Tunnel Cantilever should be obtained at most locations, there needs to be some level of “adjustability” provided in the arrangement to ensure that unforeseen site factors can still allow the Tunnel Cantilever to deliver the required Contact wire position (height & stagger). This is important to the Pantograph interface, and to also deliver the required Catenary height (with its minimum 150mm electrical clearance to tunnel lining & Catenary to Contact System Depth requirements).

All diagrams in this section of the report are based on the tunnel lining shape as provided by survey for typical locations at North Sydney.

The following issues were considered in the design of this Single-Track Tunnel Cantilever.

- a) The need to provide some insulator support plate adjustment, to cater for its position on the tunnel lining not being at the ideal angle (27° to horizon).
- b) Provide 200mm nominal clearance from Catenary to ceiling (must achieve 150mm minimum).
- c) Provide a shallow System Depth. Design should allow for at least 300 to 350mm from Catenary to Contact. See Item d) below. This can increase to about 450mm when used in conjunction with the “Heel Adjuster”.
- d) The System Depth is to remain relatively constant (at approx. 350mm). This means that the Bay Lengths are limited to approximately 30m, for minimum Dropper length of 100mm (say). Refer to the below table for typical Regulated OHW Systems (T/w=588m or 550m). It is proposed to use Bay lengths of about 25m at North Sydney. (Note that the absolute minimum available dropper length is about 90mm).

Bay (m)	Catenary Sag (m)		Minimum Dropper Length for 300mm System Depth (m)	
	T/w (m)		T/w (m)	
	550	588	550	588
20	0.091	0.085	0.209	0.215
25	0.142	0.133	0.158	0.167
30	0.205	0.191	0.095	0.109

**Table 1 - System Depth Scenarios**

- e) The Catenary is supported above the top tube member so as to maximise the available System Depth whilst maintaining electrical clearances to tunnel lining. This is important to get longer droppers as indicated in d) above.
- f) The underside of the Tunnel Cantilever arrangement needs to clear the pantograph, so the Heel height needs to be of the order of 150mm or so. Unfortunately this limits the amount of Contact Radial Load that can be tolerated. A higher Radial Load ideally should have a lower Heel height, otherwise the Arm/s tend to lift higher with the applied turning moment (Heel Height x Radial Load). A pantograph with its static uplift force of 130N further exacerbates the problem. Refer to *Table 2* and *Section 7.1*.
- g) Provision for OHW Systems that have Single or Twin Catenaries supporting Single or Twin Contacts.
- h) The Tunnel Cantilever has parts that pivot horizontally (on a vertical 19mm stainless steel pin) to allow the Catenary and Contact wires to move longitudinally (in the direction of the track) when these conductors expand & contract with temperature changes (as required by a Regulated OHW system). The horizontal distance from the pivot pin to Catenary was maximised (actually about 700mm here), consistent with the available lateral clearances for insulator support (which is very restrictive).

Reference material - for information only

<b>Pull Off Uplift Calcs</b>	<b>Twin Contact</b>			<b>Single Contact</b>	
Pan Pressure per Contact (N)	65	65	65	130	130
Contact Weight (N/m)	11.87	11.87	11.87	16.89	16.89
Contact Tension (N)	12,500	12,500	12,500	18,000	18,000
Arm Horizontal Dist (m)	0.675	0.675	0.675	0.675	0.675
Radial Load Factor (1kN)	0.01	0.033	0.066	0.03	0.066
Contact Radial Load (N)	125	413	825	540	1,188
Heel Height (m)	0.15	0.15	0.15	0.15	0.15
Contact Wire Length (m)	7.706	12.277	17.274	13.751	18.942
Weight of Wire (N)	91.5	145.7	205.0	232.3	319.9
<b>New Contact</b>					
<b>Contact Wire Uplift (m)</b>	<b>0.007</b>	<b>0.018</b>	<b>0.035</b>	<b>0.022</b>	<b>0.042</b>
Uplift With No Pan (m)	0.001	0.006	0.021	0.005	0.021
Uplift Difference (m)	0.006	0.011	0.014	0.017	0.021
<b>Worn Contact</b>					
<b>Contact Wire Uplift (m)</b>	<b>0.012</b>	<b>0.028</b>	<b>0.050</b>	<b>0.035</b>	<b>0.060</b>
Uplift With No Pan (m)	0.001	0.006	0.021	0.005	0.021
Uplift Difference (m)	0.011	0.021	0.029	0.030	0.039

**Table 2 - Contact Wire Uplift Scenarios with Regulated OHW**

- i) The main pivot pin for the thrust bearing is 19mm diameter stainless steel. To help reduce friction, the 2 bearings each have a pair of washers 50mm diameter, 1.5mm thick and made from 15% Glass Filled PTFE (the same material as used in the normal Mk2 Cantilever Jib bearing for the same purpose). The washers provide reduced friction under the heavy conductor weight load which is important. One washer is white and the other one blue so that you can tell from a distance that both have been installed.
- j) For any adjustments, the Tunnel Cantilever uses 16mm diameter stainless steel pins (a standard size in Sydney's OHW System).
- k) In providing any incremental adjustment with 16mm stainless steel pins, the minimum "edge distance" to adjacent adjustment holes in the main frame is 5mm. This required steel plates to be thicker to compensate for the small edge distance. Structural Design checks have verified that this is acceptable. Elsewhere the edge distance to the various outline edges conforms to the normal "1.5x pin diameter" rule.
- l) The resulting Catenary height depends on the geometry of the tunnel cross-section and the corresponding track position at that point of support.

In regard to Pantograph clearance to the underside of the Tunnel Cantilever, this vertical clearance is reduced with any track superelevation that causes the track to lean away from the support insulators. (This is usually the situation with Cantilevers installed around a track curve). However the reduced clearance amounts to about half the Track Super amount, since the distance from centre to edge of the pantograph is about the same distance as from centre of track to its rail (717mm). For example, a Track Super of 50mm will reduce the vertical clearance by about 25mm, which should be OK in most situations (although it still needs checking out for suitability each time Super is involved).



## 5. Configuration of the Mk-3 Tunnel Cantilever

The Tunnel Cantilever shape is shown in the “Standard Arrangement” in *Figure 6* and the optional “Heel Adjuster” is shown in *Figure 7*. Refer to Appendix “A” for the full design drawing of the arrangement.

The main parts (for discussion below) are shown in *Figure 8*.

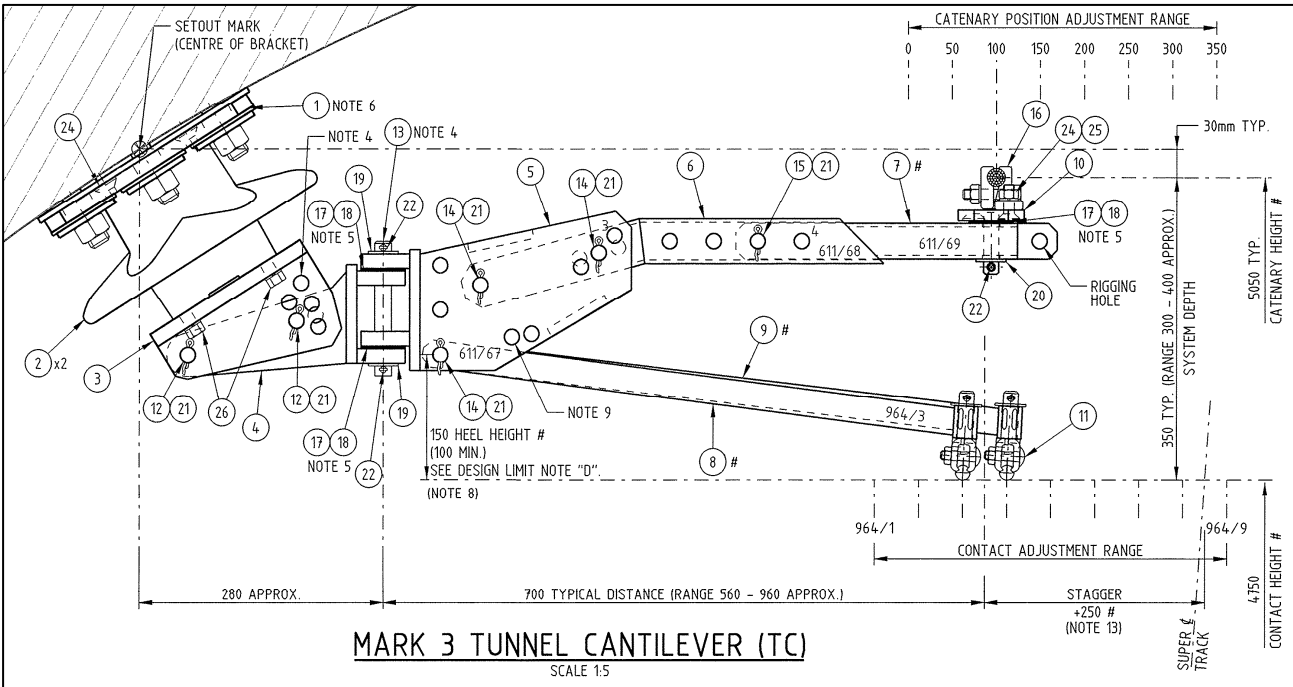

Figure 6 - Mk-3 Tunnel Cantilever from Standard Arrangement Drawing EL 0357173

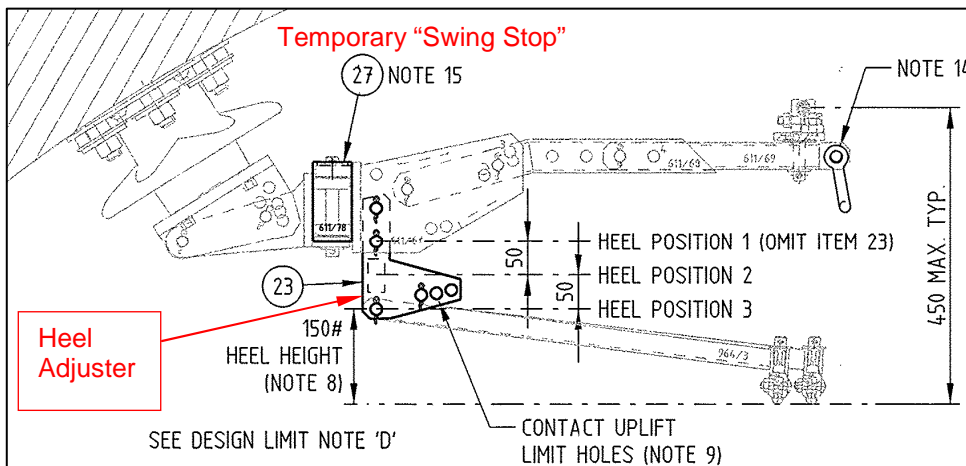

Figure 7 - Optional Heel Adjuster Detail from Drawing EL 0357173

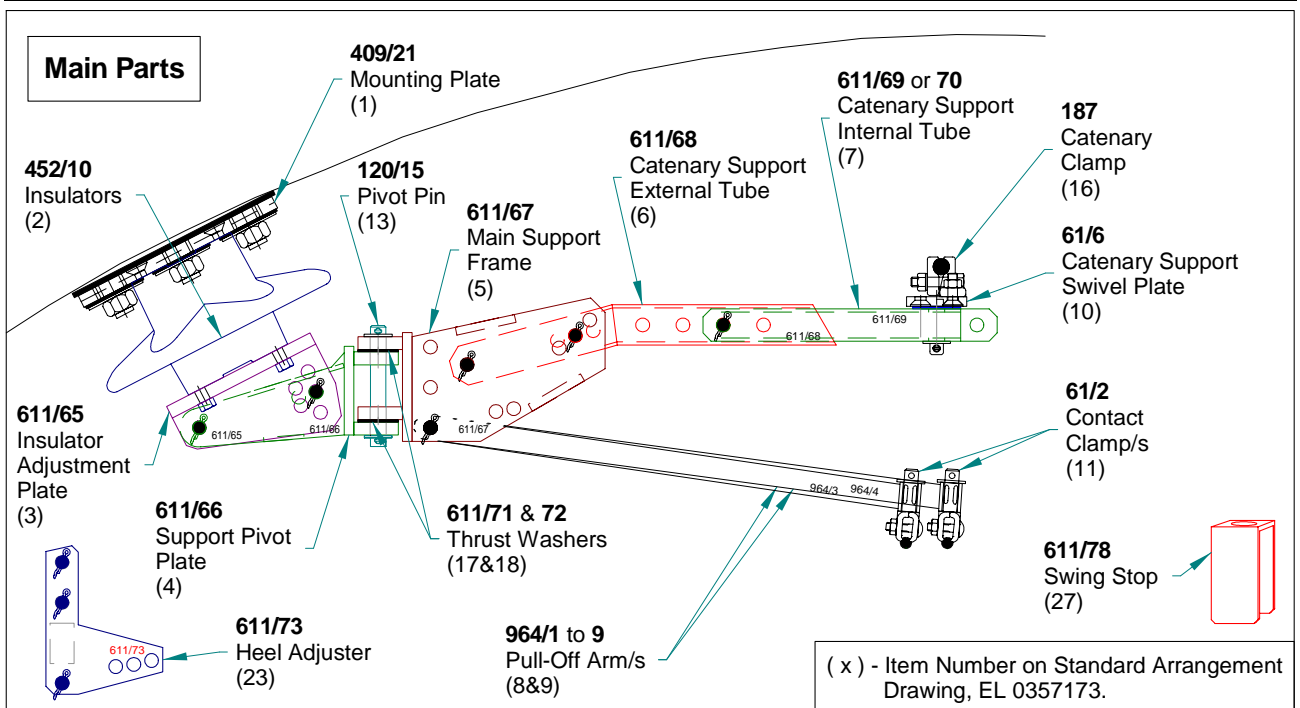
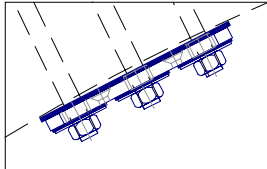
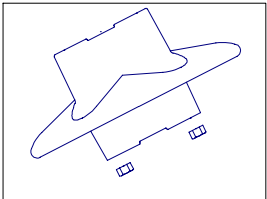
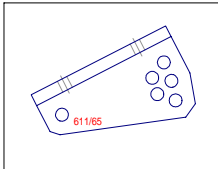

Figure 8 - Main Parts of Mk-3 Tunnel Cantilever (Part No's shown in brackets)

From the left-hand wall and generally working towards the right, the arrangement consists of the following components:

- a) Item 1 - Fitting 409/21.  
The "**Mounting Plate**".  
This steel plate is connected to the 2 post-type insulators (using 8 counter-sink set screws), then the plate is mounted onto the tunnel lining with 6 anchor bolts. The counter-sink set screws allow the plate to be mounted flush with the wall or secondary insulation plate. The skirts of the 2 insulators are positioned to almost touch (20mm gap). Two insulators are required in order to help spread the applied mechanical load. The 6 anchor bolts into the tunnel lining are comprised of 24mm stainless steel thread chemical anchors. 4 of the 6 rods are about 1.2m long and these are driven deep into the bedrock. The remaining 2 anchors are installed into the concrete lining, so as to locally lock the plate to the lining to prevent any lateral movement. The anchor bolts are provided with secondary insulation from the steel plate using 6 plastic ferrules and one plastic pad. The plastic used is an Acetal Co-polymer - Sustarin "C" (black).
 
- b) Item 2 – Fitting 452/10.  
The standard "**Post Type Insulators**".  
Two standard insulators are used to share the load and keep them well within their strength limits.
 
- c) Item 3 - Fitting 611/65.  
The "**Insulator Adjustment Plate**".  
This steel plate has 2 parallel adjustment side plates welded near the centre of the plate (the adjustment side plates are welded instead of bolted, to minimise any wasted space). The adjustment side plates are 12mm thick steel and are spaced to give a clevis of 80mm to allow attachment of the Support Pivot Plate (Item 4). These 2 plates are identical and have 1 hole at the left end, and a group of 5 holes (for adjustment) at the right end.
 



- d) Item 4 - Fitting 611/66.

The "**Support Pivot Plate**".

The main support plates have 2 parallel plates 74mm apart (outside to outside). These plates insert between the 80mm space of the adjustment side plates (above) and each have 1 hole at the left end, and 2 holes (for adjustment) at the right end. These 2 holes variously match with the above 5 holes to give a central Tunnel Cantilever support position and provision for vertical adjustment of 5° and 10° each way (up & down), ie. 5 positions are possible: -10°, -5°, 0°, +5°, +10°. (ie. 17°, 22°, 27°, 32° and 37° to the horizon).

At the other end the main support plate also has the thrust bearing to allow the cantilever to swivel horizontally with conductor expansion and contraction due to temperature changes. A pair of support "tongues", each with a 20mm hole, provide a hinged connection using a vertical 19mm stainless steel pin, and a pair of glass-filled PTFE washers are located on each of the top & bottom swivels, to help reduce friction – see Thrust Washers 611/71 & 72 below.

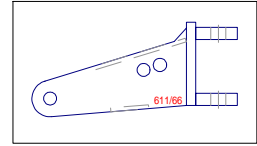

- e) Item 5 - Fitting 611/67.

The "**Main Support Frame**".

This is basically a pair of 10mm thick side plates with multiple holes for the various incremental adjustments. These plates create a clevis of 55mm and are welded to a main vertical plate at the left end. They have 2 spacer plates welded at top and lower right-hand end. At the left end this frame also incorporates an identical pair of horizontal "tongues" as Fitting 611/66 (see above), with 20mm holes for the main 19mm vertical swivel pin, which constitutes the main thrust bearing that allows the OHW conductors to move with temperature. The tongues of this fitting are placed on top of the corresponding tongues of Pivot Support Plate (Item 4), and the hinge assembly is trapped with the split pins installed at top and bottom of the inserted 19mm Pivot Pin (Item 13).

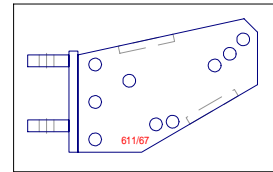

- f) Item 13 – Fitting 120/15.

The "**19mm Pivot Pin**".

This pin provides the main swivel action required as the Catenary and Contact conductors expand or contract with temperature changes in a Regulated OHW system. This pin also is meant to ensure the movement of the Catenary wire (where it is supported) moves on a horizontal plane during the swivel action, so the Catenary weight spans either side of the support do not change with temperature changes. This pin is designed to be vertical.

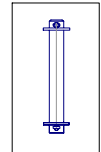

- g) Item 6 - Fitting 611/68.

The "**Catenary Support External Tube**".

The Catenary wire is supported via an external tube (50 x 50 Square Hollow Section - SHS) and internal tube (40 x 40 SHS).

The external tube pivots at its left end, and Catenary height adjustment is provided by 3 holes near the middle of the external tube. These 3 holes are designed to give 3 levels of Catenary height adjustment: if Hole 2 is used when built, it then allows for a future lowering of -50mm (in Hole 1) and a raising of +50mm (in Hole 3) in Catenary height. (However the Heel height must be checked out if and when this is done).

The right-hand end incorporates 4 holes for Catenary Stagger adjustment, in conjunction with the Internal Tubes 611/69 & 70 (see below).

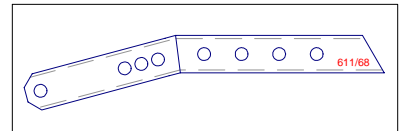

- h) Item 7 - Fittings 611/69 & 70.

The "**Catenary Support Internal Tube**".

The internal tube comes in 2 lengths, and has a locating hole at the left end and a vertical hole for the Catenary support swivel attachment at the right-hand end.

Total Catenary stagger adjustment with these 2 tubes and using the 4 holes of the External Tube (Fitting 611/68), is 350mm in 50mm increments :

- Fitting 611/69: 0 to 150mm;
- Fitting 611/70: 200 to 350mm.

At the very remote right end, a "Rigging Hole" has been provided for attaching a "Ginny Wheel" which allows convenient "stringing" of the Catenary wire during construction.

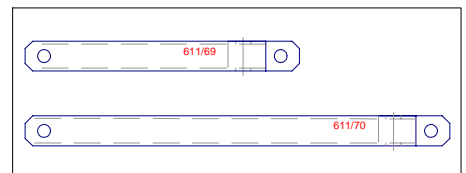

- i) Item 10 - Fitting 61/6.

The “**Catenary Support Swivel Plate**”.

This stainless steel fitting supports the Catenary wire, using an existing gunmetal Catenary Clamp (Item 16) used on Bridge arrangements (which is also used in Mk 2 Pull-Off Arrangements) ie. Fitting 187/1 for 270mm<sup>2</sup> Catenary and 187/5 for 165mm<sup>2</sup> Catenary.

The Catenary Clamp bridge fitting is mounted on this Catenary Support Swivel Plate using 2 stainless steel countersunk screws. The Swivel Plate has a 19mm diameter stainless steel shaft to allow rotation when supported on the Internal Tube (Item 7), as the Catenary wire moves with temperature (to prevent wire fatigue). This fitting is based on Fitting 61/5 (although it has a longer stem to suit the 40mm SHS and thrust washers).

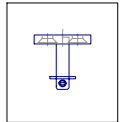

- j) Item 17 & 18 - Fittings 611/71 and 72.

The “**Catenary Support Thrust Washers**”.

One blue washer (611/71) and one white washer (611/72), these are both made from 1.5mm thick “Glass-Filled PTFE”, which has small friction but large compressive strength, as required here. The 2 different colours are needed to clearly see that the 2 washers are indeed installed as required.

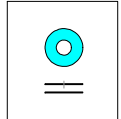

- k) Item 16 – Fitting 187.

The standard “**Catenary Bridge Clamp**”.

This fitting is usually used at Over-Line Bridges to attach the Catenary to the special “L-Irons” and provide lateral position adjustment for the Catenary.

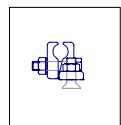

- l) Item 8 & 9 - Fittings 964/1 to 964/9.

The Contact “**Pull-Off Arm**” registration.

This uses a new Pull-Off arm configuration which has been based on previous standard arms.

For both Single and Twin Contact, arms are made from 32mm x 8mm steel plate (galvanised).

At the left-hand “Heel” end, it has a single 17mm hole, and at the right-hand end the arms have the usual welded round steel tube to accept the standard 61/2 Contact Swivel Clamp.

Note that the final Contact height is established by the Catenary height and the droppers in the adjacent bays.

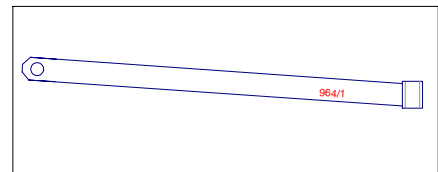

- m) Item 11 – Fitting 61/2.

The standard “**Contact Swivel Clamp**”.

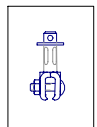

- n) Item 23 - Fitting 611/73.

The “**Heel Adjuster**”.

This device is an option, and is designed for those situations requiring greater System Depth and/or reduced Heel height. This device consists of a pair of 10mm plates with welded spacer giving a clevis of 25mm for accepting the pinned Pull-Off Arm/s. If used, it can lower the Heel height by 50mm or 100mm when inserted between the side plates of the Main Support Frame, Fitting 611/67. The outcome should achieve the design Heel height of 150mm ± 50mm.

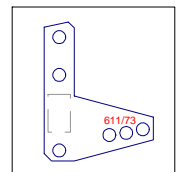

- o) Item 27 – Fitting 611/78.

The “**Swing Stop Plate**”.

This item is like a hood that is temporarily installed over the main Pivot Pin (Item 13) in order to effectively “jam” the hinge from movement. This action is only required when stringing the new Catenary wire using “Ginny Wheels”, and must be removed after the stringing has been done and the Catenary has established its equilibrium position, whence it is transferred to its final resting place on the Catenary Bridge Clamp Fitting (Item 16). This device is painted red to make it obvious, to help ensure that it is removed before the OHW is finally regulated by releasing the weights on the tensioners.

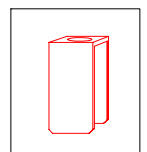

The various Tunnel Cantilever adjustments are described in the next section.



**Figure 9 - Catenary Clamp Installed on Swivel Plate**

Reference material - for information only

## 6. Adjustability Provisions

The Tunnel Cantilever is designed to provide as many points of adjustment as is practical, to help ensure that a suitable arrangement can be installed at each location (within reason). If an as-built survey of the installed Insulator Adjustment Plate (Item 3) on the live side of the insulators is made, the rest of the adjustment can be pre-determined on a cross-section of the arrangement drawn to scale on CAD.

Note: If this is done with existing OHW, then care needs to be taken to check for sufficient pantograph clearance to this bracket if existing Contact wire is higher than its final design position. (See Section 10. "Risks"). If in doubt, survey the bracket, then remove the arrangement (insulator included) until it's actually needed for running the new OHW.



**Figure 10 - Installed Tunnel Cantilever Being Adjusted**

The following adjustments are provided & discussed :

- 6.1 Insulator Support Orientation Against Tunnel Lining
- 6.2 Catenary Height Adjustment
- 6.3 Catenary Stagger Adjustment
- 6.4 Contact Stagger Adjustment
- 6.5 System Depth & Heel Height Adjustment
- 6.6 Contact Uplift Limiter



### 6.1. Insulator Support Orientation Against Tunnel Lining

The ideal configuration has the main 19mm pivot pin vertical, and the external catenary support tube horizontal. See Figure 11. To achieve this, 5 adjustment holes in 2 "columns" are provided on the Insulator Adjustment Plate (Item 3). This plate is inclined 27° to the horizon in the ideal position. To achieve this the 5 holes provide a normal 0° position (Hole 3) and 2 lots of 5° increments each side of 27° (ie. 17°, 22°, 27°, 32° & 37°).

The 5 outer holes of Item 3 can match one of the 2 inner holes provided on the Support Pivot Plate (Item 4). For correct installation, the Catenary Height Adjustment, described in Part b) below, must be in Hole 2, and only then choose which of the 5 hole combinations that makes Item 6 the most horizontal it can be.

One of the reasons for this adjustment is to ensure there's reasonable vertical clearance from pantograph to the underside of the steel plates providing such adjustment (immediately under the insulator in the diagram below). If the cantilever is installed such that it looks upward, this results in a higher Catenary & Contact height, which will reduce the vertical clearance from pan to steel support plates, which must then be checked out for sufficient pantograph clearance (the Contact wire height controls the pantograph height).

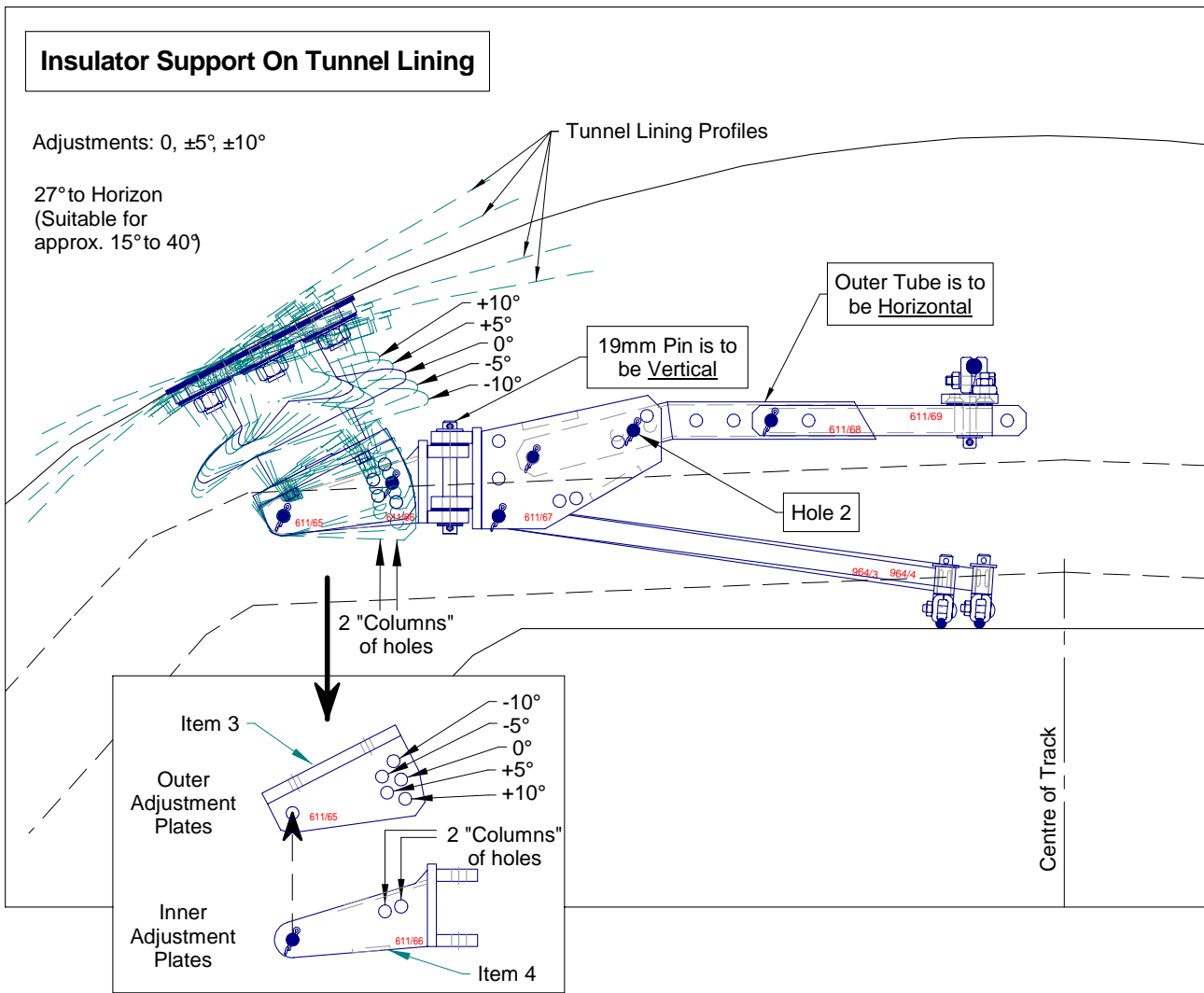

Figure 11 - Insulator Support Plate on Tunnel Lining (with Secondary Insulation)

Reference material - for information only

## 6.2. Catenary Height Adjustment

The Catenary can be adjusted approximately 50mm up or down from its mid-way position. This is achieved with 3 holes on the side of the Main Support Frame (Item 5).

Note that moving the Catenary up 50mm will reduce the clearance from Catenary to tunnel lining to about 150mm, which is the limit for electrical clearance. Note also that this will lift the Contact wire and will reduce the Heel height which may be unacceptable unless the droppers are adjusted. See *Figure 12*.

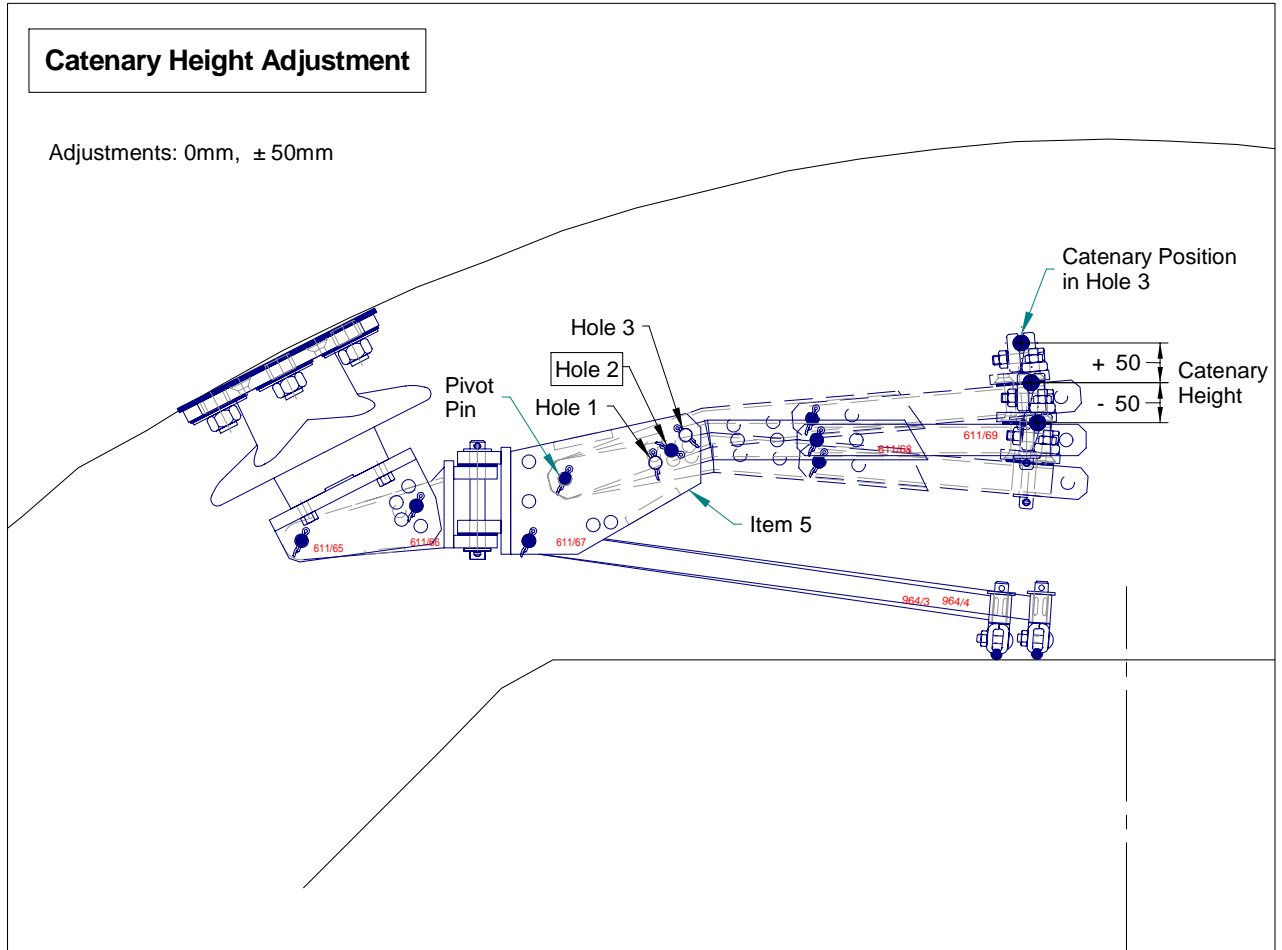

Figure 12 - Catenary Height Adjustment

### 6.3. Catenary Stagger Adjustment

The Catenary Support External Tube (Item 6) has provision for Catenary Stagger adjustment with 4 holes in the external tube, providing incremental adjustment of 50mm over a range of 150mm movement. Coupled with this, the Internal Tube (Item 7) comes in 2 lengths, so the overall Catenary stagger adjustment range is 350mm (with 8 positions), as shown in *Figure 13*.

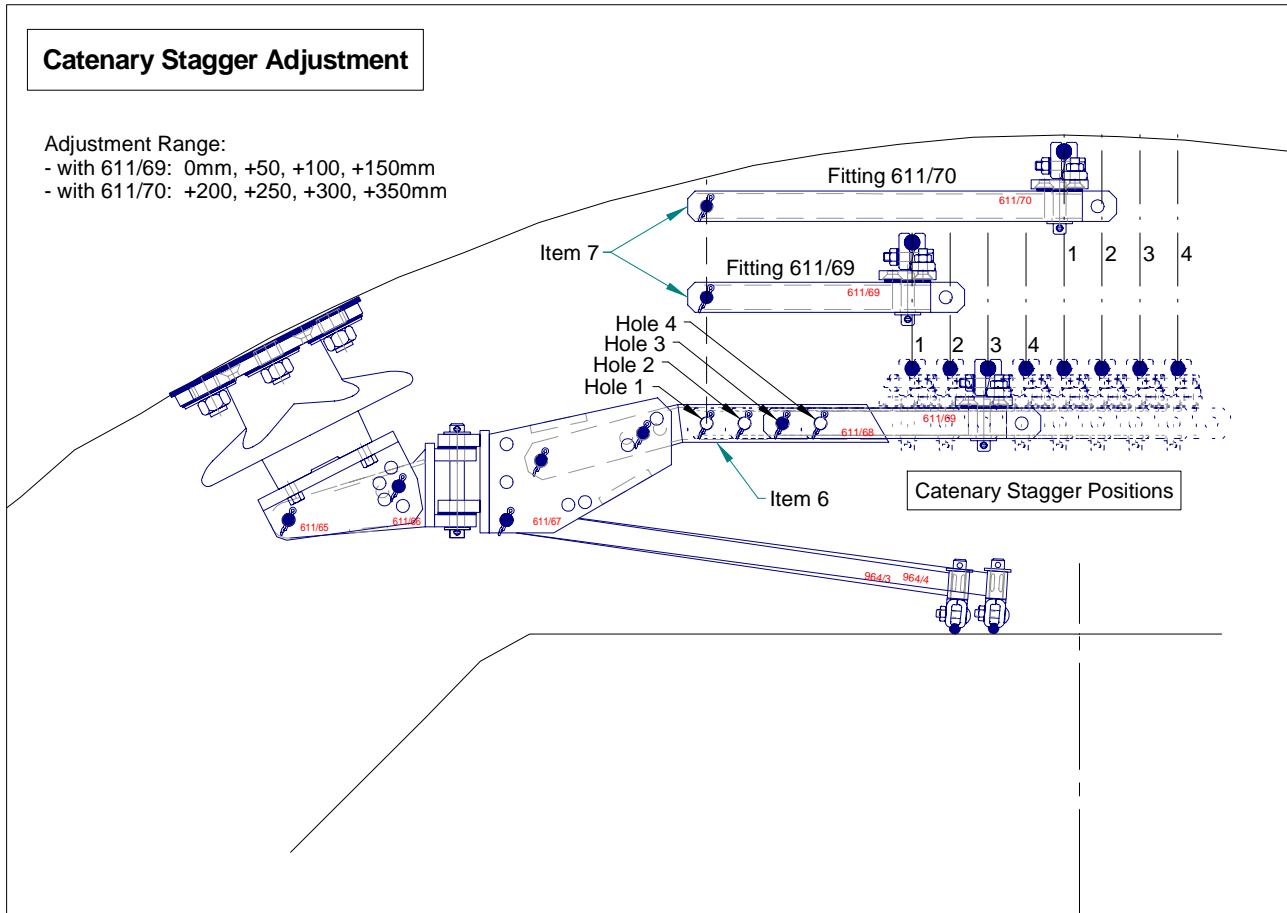

Figure 13 - Catenary Horizontal Stagger Adjustment

Reference material - for information only

## 6.4. Contact Stagger Adjustment

Special Pull-Off Arms are designed to achieve the design Contact stagger.

The Pull-Off Arms are suitable for both Single Contact and Twin Contact. They are made from 30mm x 8mm mild steel (galvanised) which is a section size consistent with other Pull-Off Arms within the Sydney OHW System. Note that this Tunnel Cantilever arrangement will not tolerate extremely high Radial Loads, so the tensile load on these Arms will not be an issue.

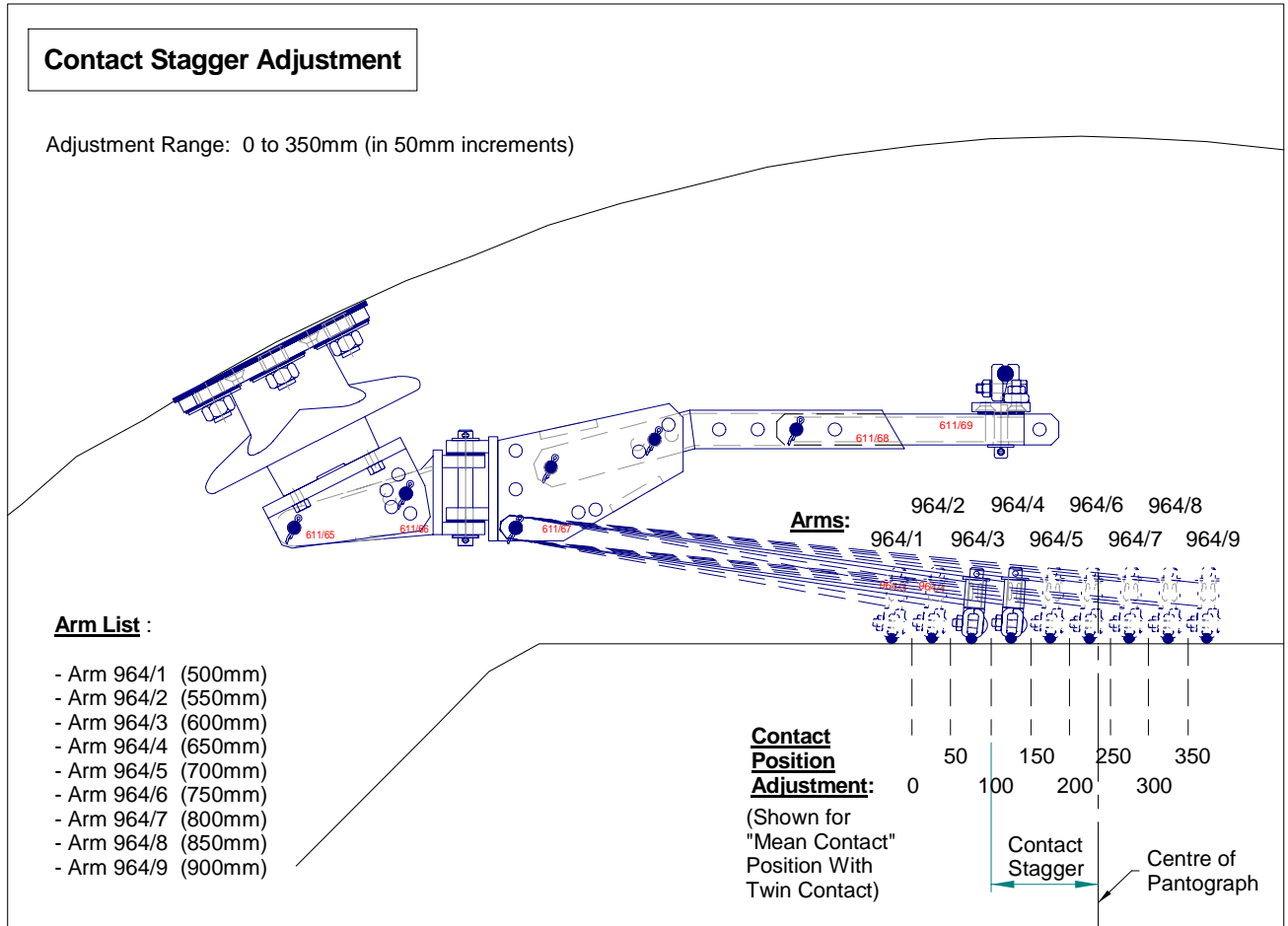

Figure 14 - Contact Stagger Adjustment

The initial proposal was to have the entire range of arm lengths made by just 2 single length parts, each with 4 holes spaced 50mm apart and bolted together using 2 of the holes. It was felt however that this configuration could lead to an undesirable failure mode over time where the bolts become loose. Instead the various arm lengths would be better made as discrete items. (They are not complicated items to make).

So the final arms are 500mm to 900mm long, in increments of 50mm (Fittings 964/1 to 9) – refer to drawing EL 0357172 in Appendix "C", Figure 14 and Figure 15.

Note that it is important to achieve the correct Contact stagger (within its tolerance of  $\pm 25\text{mm}$ ), in order to achieve Pantograph Security. So the PO arms are selected to suit the stagger (being discrete arm lengths in 50mm increments, there will nearly always be an error in actual stagger, but the resulting stagger should none-the-less be within its tolerance).

The Catenary must support the Contact, so therefore the Catenary stagger must suit the Contact stagger (and not the other way around). See Section 6.3. Again, there will be an error in Catenary stagger because of the discrete hole adjustment provided, also in 50mm increments. The resulting Catenary vertical alignment with the Contact should be within the 25mm tolerance, otherwise the next Catenary adjustment hole should be selected to achieve this 25mm tolerance figure.



Reference material - for information only

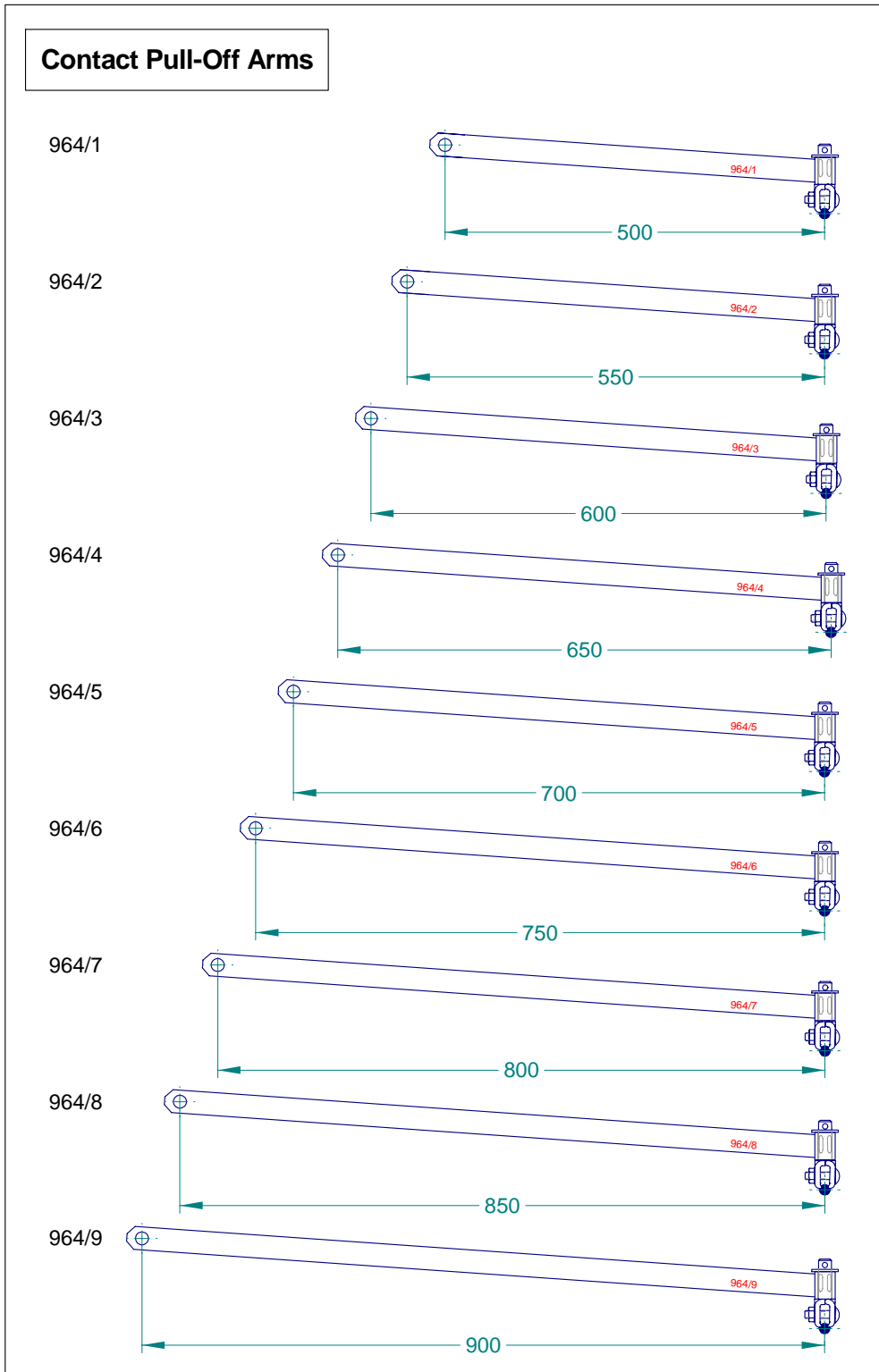

Figure 15 - Range of Pull-Off Arms (for Single & Twin Contact)

### 6.5. System Depth & Heel Height Adjustment

The actual tunnel shape and crown height above track will likely differ from location to location. Thus, the Catenary height can also be different from one location to the next. Some Catenary height adjustment is provided in this arrangement, however because of the cramped nature of these tunnels, the amount of adjustment can only be relatively small -  $\pm 50\text{mm}$ . For more detail refer to *Section 6.1* above.

So while the tunnel lining height above track at each successive OHW support location inside the tunnel can deliver different Catenary heights, and this should be readily accommodated in the design, it can also result in Contact heights that give unacceptable Contact wire Ramp Rates, and in any case the Ramp Rate for this

arrangement should be zero (flat). This is discussed in *Section 7.2 g*). Also, it may lead to insufficient Heel height.

In the OHW, it is the Contact wire that has the most importance, so gaining a suitable Contact height is a fundamental requirement of this arrangement.

In response to this, some Contact height adjustment can be provided using a special additional part - the Heel Adjuster (Item 23), as shown in *Figure 16*.

If used, this part slides up & down between the parallel support plates of the Main Support Frame (Item 5). This can give an additional 50mm or 100mm System Depth while maintaining suitable Heel height. So the System Depth can be increased from 350mm typ. to 400mm or 450mm or even slightly more.

Care needs to be exercised to ensure that the Heel height does not become so large as to cause the Contact wire to lift excessively with the applied Radial Load, especially with pantographs passing. See *Section 7. Design*.

The ideal Heel height in this Tunnel Cantilever arrangement is 150mm, with suggested absolute minimum 100mm and maximum 200mm (depending on the amount of radial load and track superelevation at a particular location).

Note that the Contact Height can be adjusted by means of suitable dropper lengths, but this is not an adjustability function of this Tunnel Cantilever.

The consequence of using longer droppers in a bay is :

- a lower Contact height, and
- a larger Heel height. This Heel height needs to be controlled, because too much Heel height with reasonable Radial Loads will cause the Contact wire to lift & reduce the vertical clearance to passing pantographs under the Tunnel Cantilever main support steelwork. (This is discussed in *Section 7. Design*).

See *Figure 17* for an example.

**System Depth Adjustment**

Adjustments: 0mm, -50mm, -100mm

a) With No Adjuster

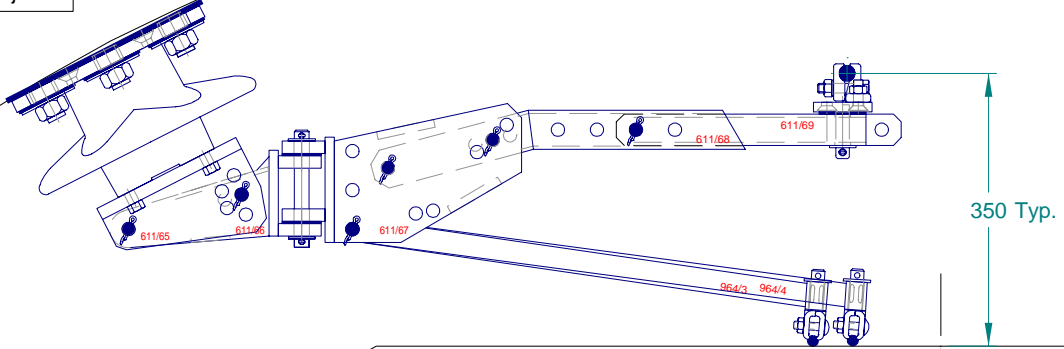

b) With Adjuster (Top Holes)

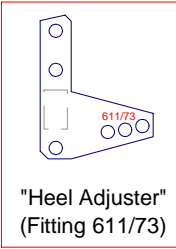
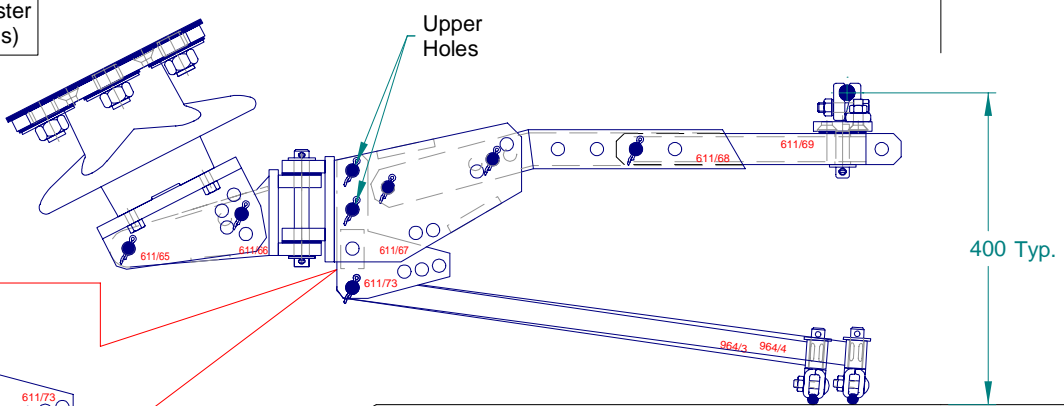

c) With Adjuster (Bottom Holes)

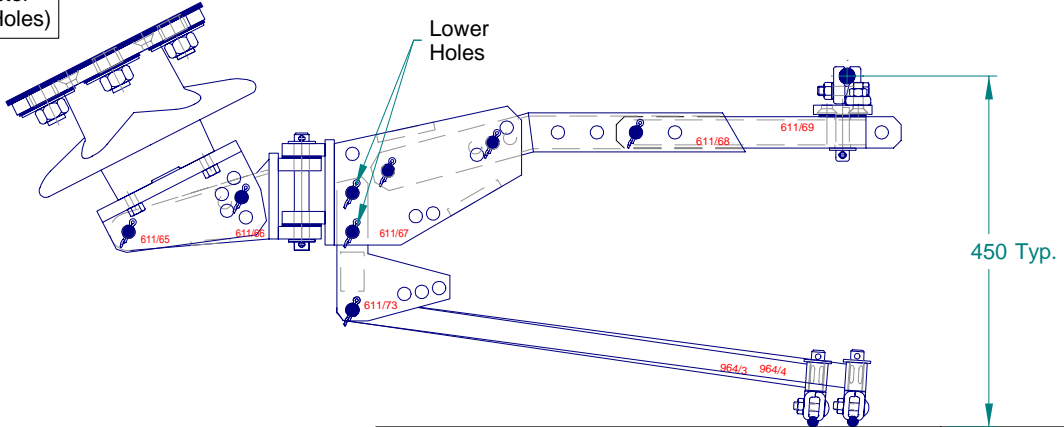

**Figure 16 - "Heel Adjuster" Installed to Vary System Depth**

Reference material - for information only

**Heel Adjustment**

Adjustments: 0mm, -50mm, -100mm

a) With No Adjuster

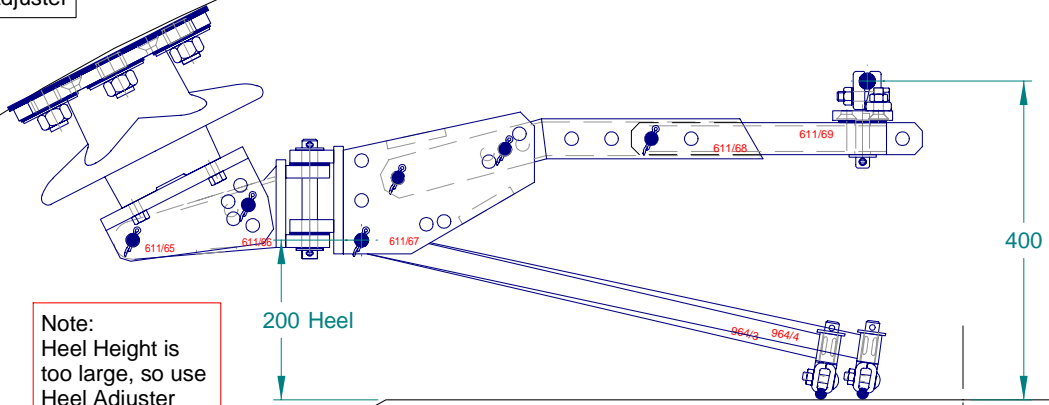

Note:  
Heel Height is too large, so use Heel Adjuster (see below)

b) With Adjuster (In Top Holes)

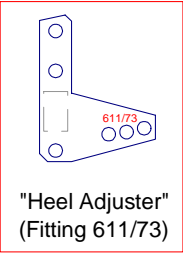
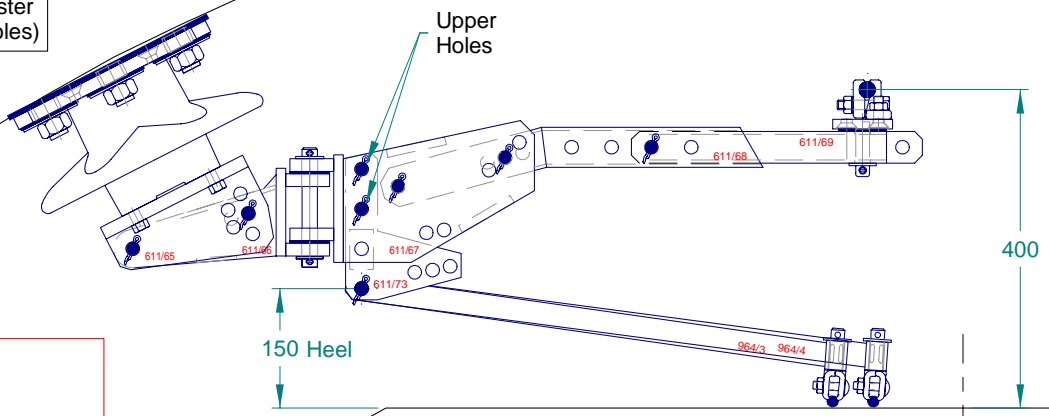

Figure 17 - Heel Adjustment

## 6.6. Contact Uplift Limiter

Provision has been made to limit the amount of Contact wire uplift due to a passing Pantograph, so as to ensure the Pantograph never strikes the underside of the Tunnel Cantilever. This feature may not be required, but is available just in case there seems to be excessive uplift (for whatever reason).

On the Main Support Frame (Item 5), two holes are provided and a single 16mm stainless steel pin is installed in the appropriate hole to help limit the Contact Uplift with passing pantograph to about 40mm. (Static calculations suggest that this 40mm is a typical maximum value, subject to reasonable Contact Radial Load / Heel height combinations). A 3<sup>rd</sup> limit level is achieved with the steel spacer on the diagonal member of the Main Support Frame (Item 5). See *Figure 18*.

These 2 holes (and 3<sup>rd</sup> limiter) are generally consistent with the tolerance error involved in getting the main 19mm Pivot Pin (Item 13) to be vertical, ie.  $5^\circ \div 2 = 2.5^\circ$  as per *Section 6.1* above.

The Uplift Limiter feature is also provided with 3 holes in the Heel Adjuster (Item 23) to achieve the same outcome. See bottom diagram in *Figure 18*.

Note: Only install a pin if uplift is likely to be a problem – ideally there should be no need for this limiter.

**Uplift Limiter**

Adjustments: 0mm, -50mm, -100mm

a) With No Adjuster

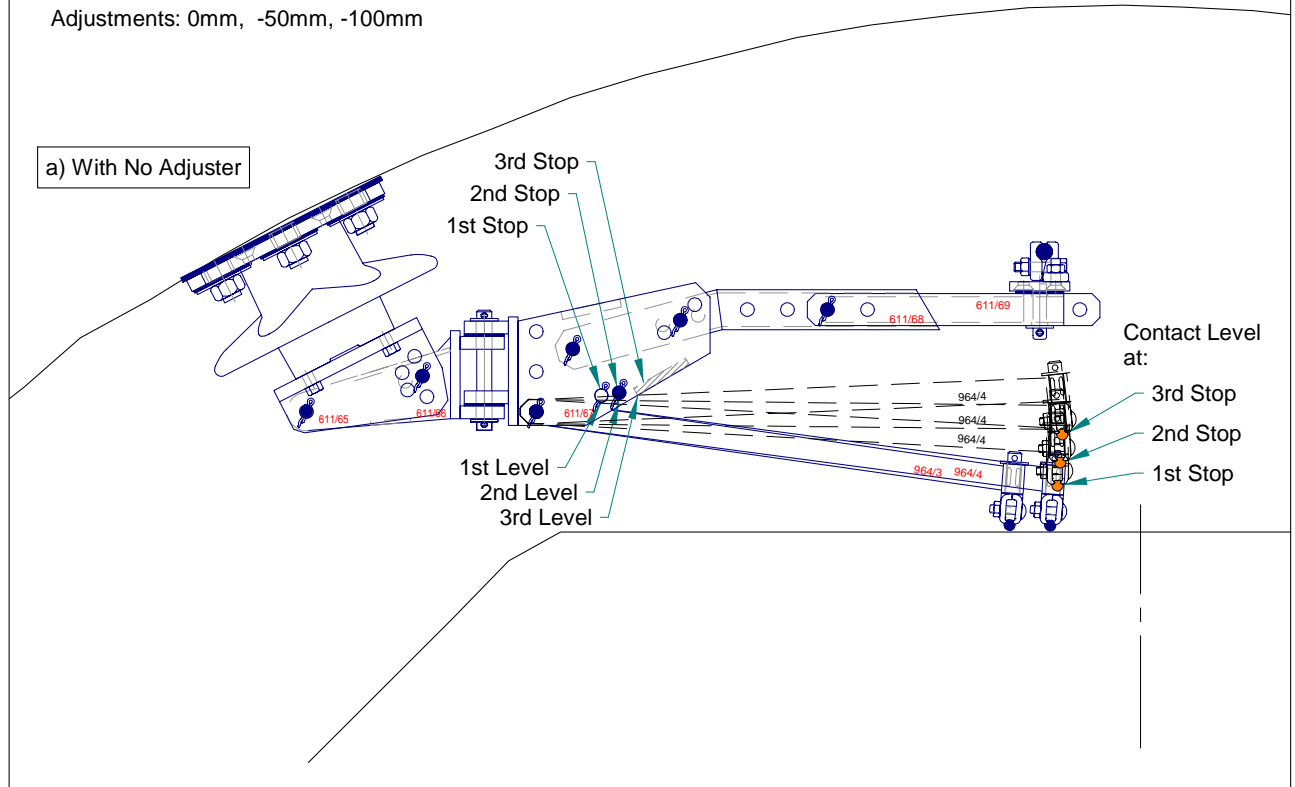

b) With Adjuster  
(In Top Holes)

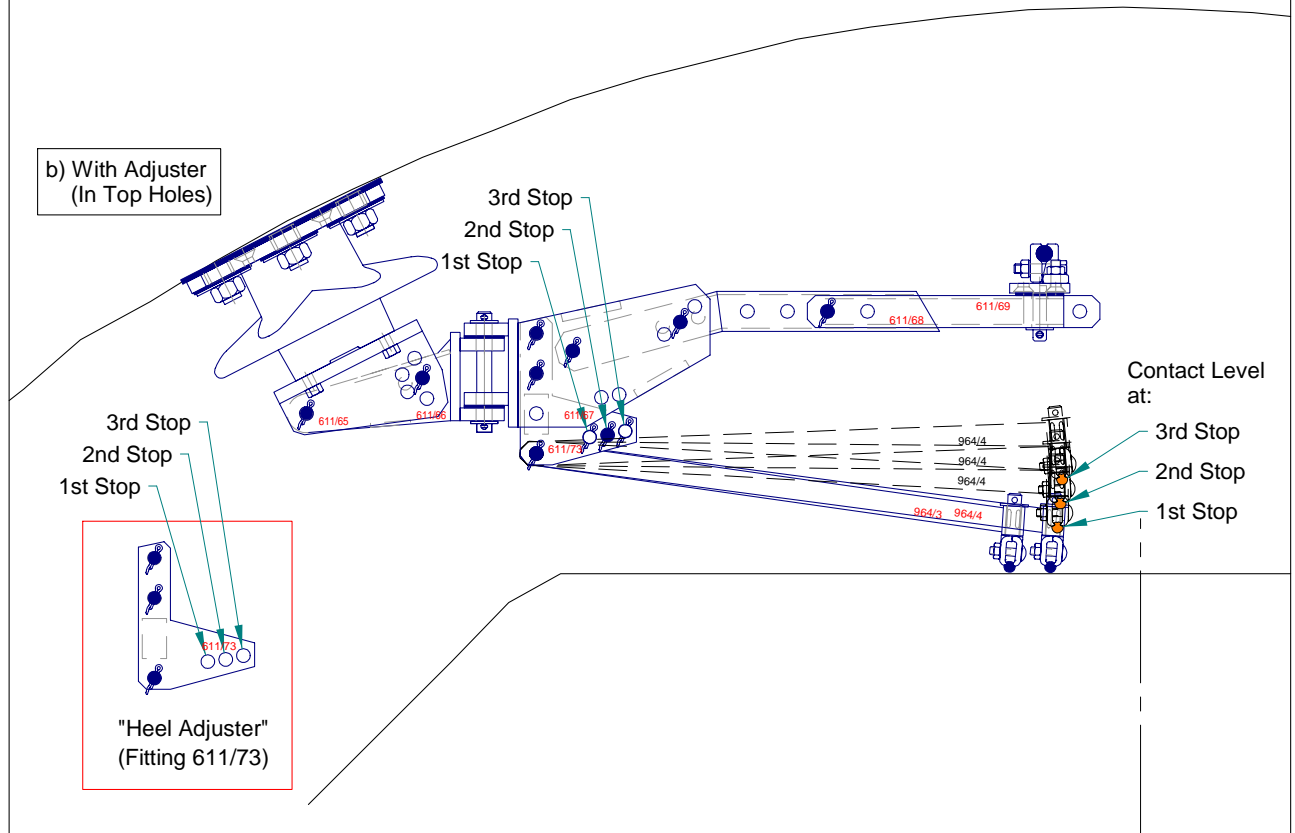

**Figure 18 - Provision for Contact Uplift Limiting (if required)**

## 7. Design Aspects

Because of its compact size in the small available headroom of a single-track tunnel, this type of Tunnel Cantilever necessarily requires some limits to be placed on it for proper functioning, as listed below. If it is planned to approach or exceed these suggested limits, detailed calculations need to be done to support such a decision.

### 7.1. How the Cantilever Works

To understand some of the limitations, an understanding is required of how this Tunnel Cantilever works, especially in terms of how the Contact Radial Load and the Heel Height affect **Contact Uplift**, both in the static situation and also with pantograph upward pressure applied. Refer to simplified situation shown in *Figure 19*.

The small space available for OHW support & registration equipment inside a single track tunnel necessarily requires a short pull-off arrangement. This is unfortunate as it will lead to a greater uplift force on the Contact wire due to any applied Radial Load – the higher the Radial Load the higher the uplift force. A higher uplift force can lead to the pantograph rising, which in turn can cause problems with pantograph clearance to the under-side of Tunnel Cantilever equipment located above, unless this clearance has been assessed to be suitable.

*Figure 20* shows a 3-dimensional stick diagram of a typical situation with the Catenary wire supported by some frame, and the Contact wire registered by a straight pull-off arm back to a “Pivot Point” which allows the arm to rotate up and down (mostly to allow for pantograph uplift).

This diagram is intended to show how Radial Load on the Contact wire causes the Contact wire to lift to an equilibrium point, and when a pantograph passes under the arm, its upward pressure causes the Contact wire to rise to a new higher equilibrium point, which is counteracted by the additional weight of the Contact wire being supported at the end of the arm.

#### a) Normal State:

The Radial Load on the Contact wire causes the Contact wire to lift at the end of the pull-off arm. This is caused by the turning moment about the Pivot Point due to the Heel height.

However, the raised Contact wire (from its flat position) imposes Contact weight at the end of the arm, given by:

$$\text{Contact Weight (N)} = \text{Distance Between Contact Low Points (m)} \times \text{Contact Weight (N/m)}$$

Note: the Distance between adjacent Contact Low Points is shown in *Figure 20* as “L(Static)”

A raised Contact height will lead to a reduced Heel height (by the same amount). This “Actual” Heel height is therefore a variable. Its reduction can work in our favour as it helps reduce the upward turning moment and therefore reduces the amount of Contact wire uplift.

The Contact height is in equilibrium when the sum of the turning moments is balanced, ie. when

$$\{\text{Radial Load}\} \times \{\text{Actual Heel Height}\} = \{\text{Contact Weight}\} \times \{\text{Arm Distance}\}$$

#### b) With Pantograph Uplift Force:

If a pantograph parks itself under the Contact wire at this location, the upward Pan force tends to lift the Contact wire further up. However this causes the Contact Low Points to shift further apart away from the arm connection, shown in *Figure 20* as “L(Pan)”, and this causes more Contact Weight to be applied at the end of the arm, which in turn counteracts the Pan’s uplift force.

Again, the Contact height is in equilibrium when the sum of the turning moments is balanced, ie. when

$$\{\text{Radial Load}\} \times \{\text{Actual Heel Height}\} + \{\text{Pan Uplift Force}\} = \{\text{New Contact Weight}\} \times \{\text{Arm Distance}\}$$

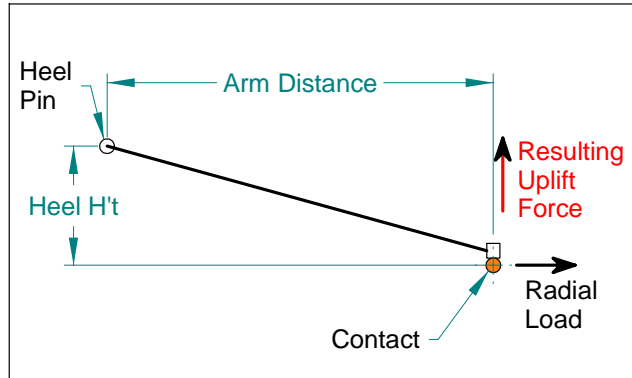

**Figure 19 - Contact Uplift Resulting from Heel Height & Radial Load**

Note: the Distance between adjacent Contact Low Points is shown in *Figure 20* as "L(Pan)"

So in the above analysis, even though the design Heel height is reduced, which reduces the Pan vertical clearance at the Heel end of the arm (which is no good), this can also work in our favour as it helps reduce the upward Turning Moment and therefore lessens the amount of Contact wire uplift (which is a good thing). It's a bit of a balancing act. The end Heel clearance is what is important & must be checked out for each instance of this type of Tunnel Cantilever.

There is a spreadsheet program that helps analyse this situation (as shown in *Table 2* and below in *Table 3*, *Table 4* and *Table 5*).

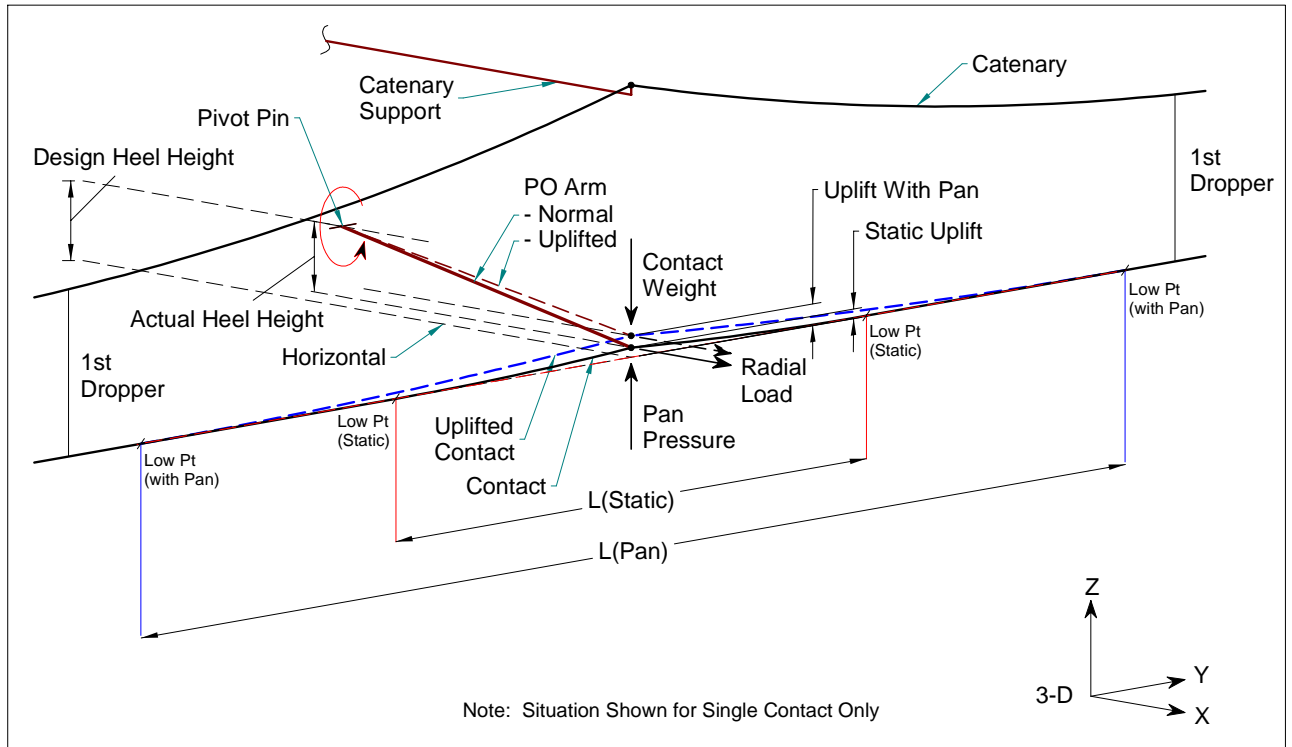
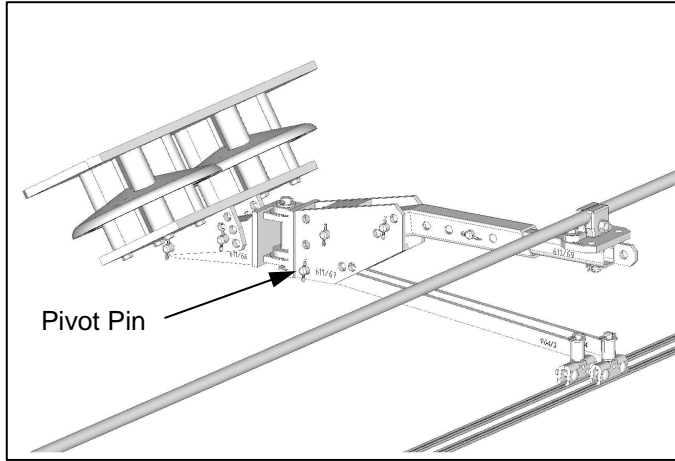

Figure 20 - 3-D View of Contact Uplift in Equilibrium

As mentioned previously, the new arrangement requires the use of short pull-off arm/s, and this means that the heel end of the arms will be located directly above the pantograph, and not to the side (which is contrary to the more usual practice). Contrast 500mm arm length here with the more usual 1,200mm arm length.



Normally with pull-off arrangements, the combined distance of :

$$(\text{“Stagger”} + \text{“Arm Length”}) > \text{about } 1,350\text{mm.}$$

Achieving this clearance generally ensures that the Heel of the arm (which only has about 50mm Heel height) is well clear of the closest edge of a passing pantograph in its “Raised & Oscillated” position.

In contrast, the new Tunnel Cantilever has short arms, so it relies on vertical clearance above the pantograph (rather than the 1,350mm side clearance mentioned above). So this requires a larger-than-normal Heel height (150mm) to gain the necessary clearance to pantographs below.

In summary, for this Tunnel Cantilever to work, a larger Heel height must be maintained, but this brings its own problems if there is also a medium to high Contact Radial Load on the pull-off arms. *Figure 19* is intended to help understand this situation.

In regard to Heel height, unfortunately a high Heel height limits the amount of Contact Radial Load that can be tolerated. A higher Radial Load ideally should go with a lower Heel height, otherwise the Arm/s tend to lift higher with the applied turning moment (Heel Height x Radial Load).

This is a compromise, because of the dynamics of the pantograph requiring a Heel height (vertical clearance to underside of Tunnel Cantilever) of at least about 100mm (ideally it should be 150mm). For example, a large 200mm Heel height will give plenty of vertical clearance to the pantograph, but will tend to cause the Contact wire to lift higher as the pantograph passes (with the same Radial Load), and this is not desirable.

The pantograph static upward pressure is typically about 130N as per the Electrification Standard. (Because track speed for the Tunnel Cantilever is limited to about 60km/h as mentioned in Section 7.2, there should be very little if any additional “dynamic” uplift force).

In the case of Twin Contact OHW Systems, this 130N is spread over 2 Contact wires (65N per wire) which tends to help control uplift.

For this Tunnel Cantilever to work, it is likely that the Radial Load will need to be limited to something like a Type 2 Situation, ie.

- 1,200N maximum for Single 193mm<sup>2</sup> Contact (= about 42mm Uplift @ 130N Pan Pressure & 1,200N RL), &
- 1,600N maximum (ie. 2 x 800N) for Twin 137mm<sup>2</sup> Contact (= about 35mm Uplift @ 65N Pan Pressure & 800N RL).

For North Sydney the absolute maximum Radial Load on each 137mm<sup>2</sup> Contact wire is about 800N (3<sup>rd</sup> column in *Table 2*). This is the limit of the 2<sup>nd</sup> dot point above, and according to the table should give only 35mm Contact uplift, which should be acceptable.

To get a “feel” of how the Arm Length, Radial Load and Heel Height interact, the following 3 Tables show what happens when one of these variables is changed (in turn) with the remaining 2 variables kept constant.

*Table 3* below shows the relative effect on Uplift by changing the length of the Pull-Off Arms (with all other variable kept constant) :

- The first column uses the shortest arms - 500mm and 550mm arms (average is 525mm),
- The second column uses 650mm and 700mm arms (average is 675mm),
- The third column uses the longest arms - 850mm and 900mm arms (average is 875mm)

This Table shows that the longer the Arm Length, the less the Contact Uplift. So when designing a particular instance of the Tunnel Cantilever, aim for long arms.

<b>Pull Off Uplift Calcs</b>	<b>Twin Contact</b>		
Pan Pressure per Contact (N)	65	65	65
Contact Weight (N/m)	11.87	11.87	11.87
Contact Tension (N)	12,500	12,500	12,500
<b>Arm Horizontal Dist (m)</b>	<b>0.525</b>	<b>0.675</b>	<b>0.875</b>
Radial Load Factor (1kN)	0.033	0.033	0.033
Contact Radial Load (N)	413	413	413
Heel Height (m)	0.15	0.15	0.15
Contact Wire Length (m)	13.889	12.277	10.876
Weight of Wire (N)	164.9	145.7	129.1
<b>New Contact</b>			
<b>Contact Wire Uplift (m)</b>	<b>0.023</b>	<b>0.018</b>	<b>0.014</b>
Uplift With No Pan (m)	0.010	0.006	0.004
Uplift Difference (m)	0.013	0.011	0.010
<b>Worn Contact</b>			
<b>Contact Wire Uplift (m)</b>	<b>0.035</b>	<b>0.028</b>	<b>0.022</b>
Uplift With No Pan (m)	0.010	0.006	0.004
Uplift Difference (m)	0.024	0.021	0.018

**Table 3 - Effect on Uplift by Changing Arm Length**

Table 4 below shows the relative effect on Uplift by changing the length of the Radial Load (with all other variable kept constant) :

- The first column uses a small Radial Load Factor (0.001), based on 1kN tension,
- The second column uses the maximum Type 1 Radial Load Factor (0.033),
- The third column uses the maximum Type 2 Radial Load Factor (0.066).

This Table shows that the smaller the Radial Load, the less the Contact Uplift. So when designing a particular instance of the Tunnel Cantilever, try to minimise the Radial Load, eg. by a suitable Staggering pattern.

<b>Pull Off Uplift Calcs</b>	<b>Twin Contact</b>		
Pan Pressure per Contact (N)	65	65	65
Contact Weight (N/m)	11.87	11.87	11.87
Contact Tension (N)	12,500	12,500	12,500
Arm Horizontal Dist (m)	0.675	0.675	0.675
<b>Radial Load Factor (1kN)</b>	<b>0.001</b>	<b>0.033</b>	<b>0.066</b>
Contact Radial Load (N)	13	413	825
Heel Height (m)	0.1	0.15	0.2
Contact Wire Length (m)	5.626	12.277	20.788
Weight of Wire (N)	66.8	145.7	246.8
<b>New Contact</b>			
<b>Contact Wire Uplift (m)</b>	<b>0.004</b>	<b>0.018</b>	<b>0.051</b>
Uplift With No Pan (m)	0.000	0.006	0.034
Uplift Difference (m)	0.004	0.011	0.017
<b>Worn Contact</b>			
<b>Contact Wire Uplift (m)</b>	<b>0.006</b>	<b>0.028</b>	<b>0.071</b>
Uplift With No Pan (m)	0.000	0.006	0.034
Uplift Difference (m)	0.006	0.021	0.036

**Table 4 - Effect on Uplift by Changing Radial Load**

Reference material - for information only

Table 5 below shows the relative effect on Uplift by changing the Heel Height.

- o The first column uses the smallest Heel height (100mm),
- o The second column uses the design Heel height (150mm),
- o The third column uses the maximum Heel height (200mm).

This Table shows that the smaller the Heel Height, the less the Contact Uplift. So when designing a particular instance of the Tunnel Cantilever, aim for the standard 150mm Heel Height.

Pull Off Uplift Calcs	Twin Contact		
Pan Pressure per Contact (N)	65	65	65
Contact Weight (N/m)	11.87	11.87	11.87
Contact Tension (N)	12,500	12,500	12,500
Arm Horizontal Dist (m)	0.675	0.675	0.675
Radial Load Factor (1kN)	0.033	0.033	0.033
Contact Radial Load (N)	413	413	413
<b>Heel Height (m)</b>	<b>0.1</b>	<b>0.15</b>	<b>0.2</b>
Contact Wire Length (m)	10.012	12.277	14.490
Weight of Wire (N)	118.8	145.7	172.0
<b>New Contact</b>			
Contact Wire Uplift (m)	<b>0.012</b>	<b>0.018</b>	<b>0.025</b>
Uplift With No Pan (m)	0.003	0.006	0.011
Uplift Difference (m)	0.009	0.011	0.014
<b>Worn Contact</b>			
Contact Wire Uplift (m)	<b>0.019</b>	<b>0.028</b>	<b>0.038</b>
Uplift With No Pan (m)	0.003	0.006	0.011
Uplift Difference (m)	0.016	0.021	0.027

**Table 5 - Effect on Uplift by Changing Heel Height**

**Observation :**

In February 2013 the first lot of Mk-3 Tunnel Cantilevers were installed (5 in total) with the new regulated twin Contact OHW for the Up Shore. With “Hands-on” the OHW, the amount of manual effort required to lift the twin Contacts in the case of high radial load (just under 800N per wire), was considerable.

It gave some confidence that the uplift with pantographs passing at low speed should not be an issue.

## 7.2. Limitations & Reasons

The limitations on the Mk-3 Tunnel Cantilever must be considered during the design of each individual application of this Tunnel Cantilever arrangement.

- a) **Tension Mode.** For use with Regulated OHW only.

**Reason:**

The conductor tensions in a Regulated Tension OHW system remain constant (typ. within +/-10%), so the Catenary and Contact radial loads and Catenary weight load on the tunnel cantilever remains relatively constant. Unfortunately, a Fixed Anchored OHW system cannot maintain constant tension, and this affects the radial loads and even the weight load (if the Catenary low points either side of the support move).

It is particularly important that the Contact radial load does not increase significantly, since the amount of Contact uplift will increase, and the amount of Heel height will decrease with increased Contact radial load. Both of these factors can lead to reduced vertical clearance from top of pantograph to underside of tunnel cantilever (the Heel of the arm), which can ultimately lead to a collision.

For Fixed-Anchored OHW:

- Under Hot conditions the Contact tension can plummet (eg. 13kN at 21°C to 2kN at 50°C). This can increase pantograph uplift quite significantly.
- Under Cold conditions the Contact tension can increase significantly (eg. To 22kN in the above example). This can cause the Heel height to reduce as the increased Radial Load (due to increased tension) wants to align the Contact wire horizontally with its pivot point.

One of the reasons the Tunnel Cantilever can use straight arms (with no crank) and a heel connection located above passing pantographs, is because the Contact tension (and therefore Contact uplift) can be much better controlled with regulated OHW than with Fixed Anchored OHW. Refer back to *Table 2*.

- b) **Tension Length.** Tunnel Cantilever to be located within approximately 500m of Fixed Anchor or Fixed Mid-Point location (due to limited cantilever swing with temperature).

**Reason:**

There is only a relatively short pull-off arm arc radius from Contact wires to the main 19mm vertical Pivot Pin (Item 13) of about 700mm. This means that, as the Contact wire moves in the along-track direction in response to temperature changes, this short arc radius causes a greater Stagger change (which is perpendicular to the wire movement) than what would occur with the normally larger arc radius of about 1,400mm.

For example, a tension length of 500m with a temperature change of 30°C will cause a wire length change at this point of 255mm, giving a Stagger error of 48mm, and 50mm is considered the maximum tolerable error here. Refer to *Figure 21*. The 30°C approximates -5°C to 25°C (Cold condition) and more importantly 25°C to 55°C (Hot condition).

(Note that it is extremely unlikely to get to -5°C – we're more concerned with the hot temperature condition here because it is less well controlled).

Also shown on *Figure 21* is a Stagger error of 25mm resulting from 185mm of wire movement, which corresponds to 363m of wire from the Fixed Anchor for the 30°C temperature change.

Appendix "H" shows an "OHW Conductor Movement / Temperature Chart", which gives an idea of the relative movement of the conductors versus temperature. This chart should be used when setting up the Tunnel Cantilevers.

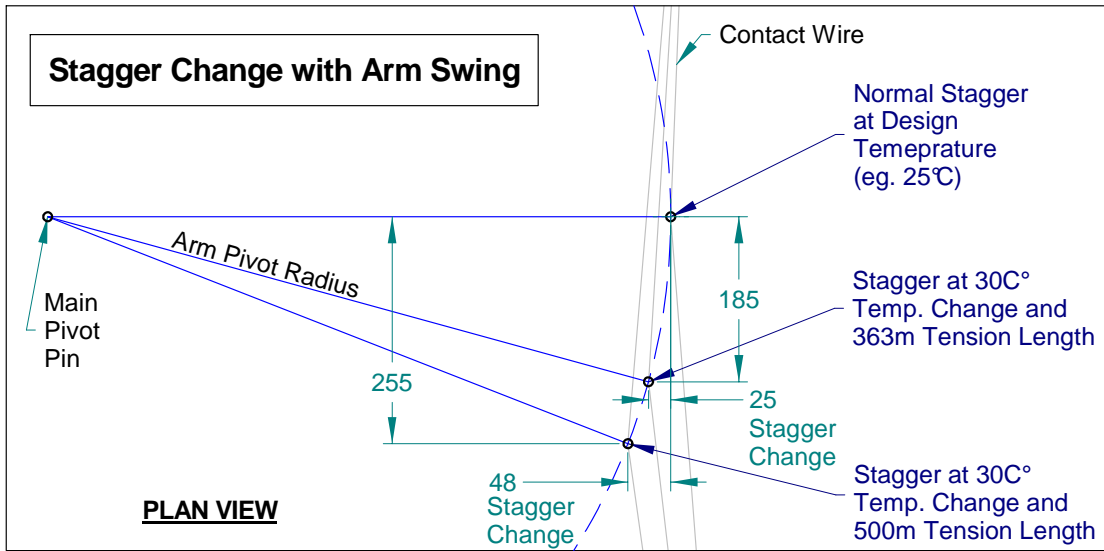

Figure 21 - Stagger Error With Cantilever Arm Swing

- c) **Wire Loading.** Total Contact Load (Radial + Wind) limited to 1.6kN for Twin Contact and 1.2kN for Single Contact OHW, subject to uplift considerations. Radial Load should be positive (acting away from support insulators). Any compressive load to be less than 200N per wire.

**Reason:**

In this Tunnel Cantilever arrangement, the Contact radial load has a direct effect on the Heel height – the higher the Radial Load, the lower the Heel height. In turn, a reduced Heel height also reduces the vertical clearance from a pantograph to the heel of the pull-off arm/s and under-side of the tunnel cantilever frame, and this reduced clearance may increase the risk of collision of pan with the Tunnel Cantilever.

The above Radial Load limits are the maximum Type 2 loads without wind (there’s normally no cross wind inside tunnels anyway).

- d) **Heel Height.** Design Heel height of 150mm is critical in this design. To ensure suitable pantograph clearance, actual Heel height is not to be less than 100mm. To limit pantograph uplift, Heel height should not exceed 200mm.

**Reason:**

A small Heel height means a small vertical clearance from a passing pantograph to the under-side of the TC frame, and this increases the risk of pantograph collision. However a large Heel height will cause the Contact wire to lift.

- Heel must be greater than about 100mm, otherwise it might affect Pantograph clearances to the under-side of the Tunnel Cantilever.
- Heel must be less than about 200mm (and this depends on having a relatively small Contact Radial Load, otherwise the Contact will rise to reduce the Heel height). Again this probably needs to be assessed in each case where Heel height approaches 200mm.

- e) **Contact Uplift.** Designer must determine how much the Contact wire lifts with radial load and pantograph uplift pressure, and ensure a suitable Heel height is chosen. Higher radial loads may not be suitable. The situation with worn Contact wire (ie. less mass to control the pantograph) should also be assessed.

**Reason:**

The amount of Contact uplift is a function of :

- Pantograph upward pressure,
- Number of Contact wires (1 or 2),
- The linear weight (N/m) of each Contact wire,

- The amount of Radial Load on each Contact wire,
- The Heel height on the arm/s.

Refer to *Figure 19*.

The Heel height is a result of the above forces in equilibrium. There is a spreadsheet program that helps determine the resulting Heel height, both without the pan pressure and also with it applied. Refer to *Table 2* for an example of the spreadsheet.

- f) **Bay Lengths**. To be limited to 30m maximum in the bay before & after the arrangement.

***Reason:***

Large Bay lengths give rise to larger pantograph uplifts. (This is a consequence of the reduced Catenary sag at mid-bay when a pantograph unloads the Contact wire through the Bay and the lighter Catenary rises in response. As the Catenary rises it brings the Contact wire up as well via the droppers supporting it in the Bay).

Conversely, short Bays give little Contact wire disturbance as the pan passes through the Bay, which is a desirable outcome for this Tunnel Cantilever.

- g) **Contact Ramp Rate**. Ideally to be zero in the bay before and after the arrangement (1/1,000 maximum).

***Reason:***

Having no Ramp Rate on the Contact wire (ie. flat wire) in the Bays surrounding the Tunnel Cantilevers should help to minimise any upward disturbance to the Contact wire when a pantograph passes through these Bays, which is desirable.

- h) **Track Speeds**. Suitable up to approx. 60km/h, unless a dynamic simulation of uplift determines otherwise.

***Reason:***

It is felt that train pantograph speeds less than about 60km/h should not introduce any significant travelling waves in the Contact wire. Travelling waves can cause significant Contact wire uplift which must be avoided with these Tunnel Cantilevers. North Sydney only has track speeds of up to 60km/h.

- i) **Track Superelevation**. High Superelevation (typically > 100mm) must be taken into account when determining the minimum Heel height (due to reduced pantograph clearance to underside of pull-off arrangement).

***Reason:***

Any Tunnel Cantilever supporting OHW over a curved track will more than likely be located on the outside of the curve because of the direction of the radial load (thus giving a “positive” radial load that puts the arm into tension).

In this situation the pantograph tilts to the degree that the track tilts with superelevation (the pantograph head and track rails are co-planar). This in turn results in a reduced vertical clearance from edge of pantograph to the underside of the Tunnel Cantilever arrangement, which if excessive may risk pan collision with the Tunnel Cantilever.

The amount of reduced vertical clearance is approximately half the amount of track superelevation, eg. if the Super is 50mm, then the amount of reduced vertical clearance is 25mm (compared to the situation with no track Super). Refer to *Figure 22* which shows this example. Note that the width of a pantograph is approximately the same as the track gauge.

It would have been better if the Tunnel Cantilever were installed on the opposite side, which would result in greater clearances, but this cannot happen due to the direction of Radial Load.

Reference material - for information only

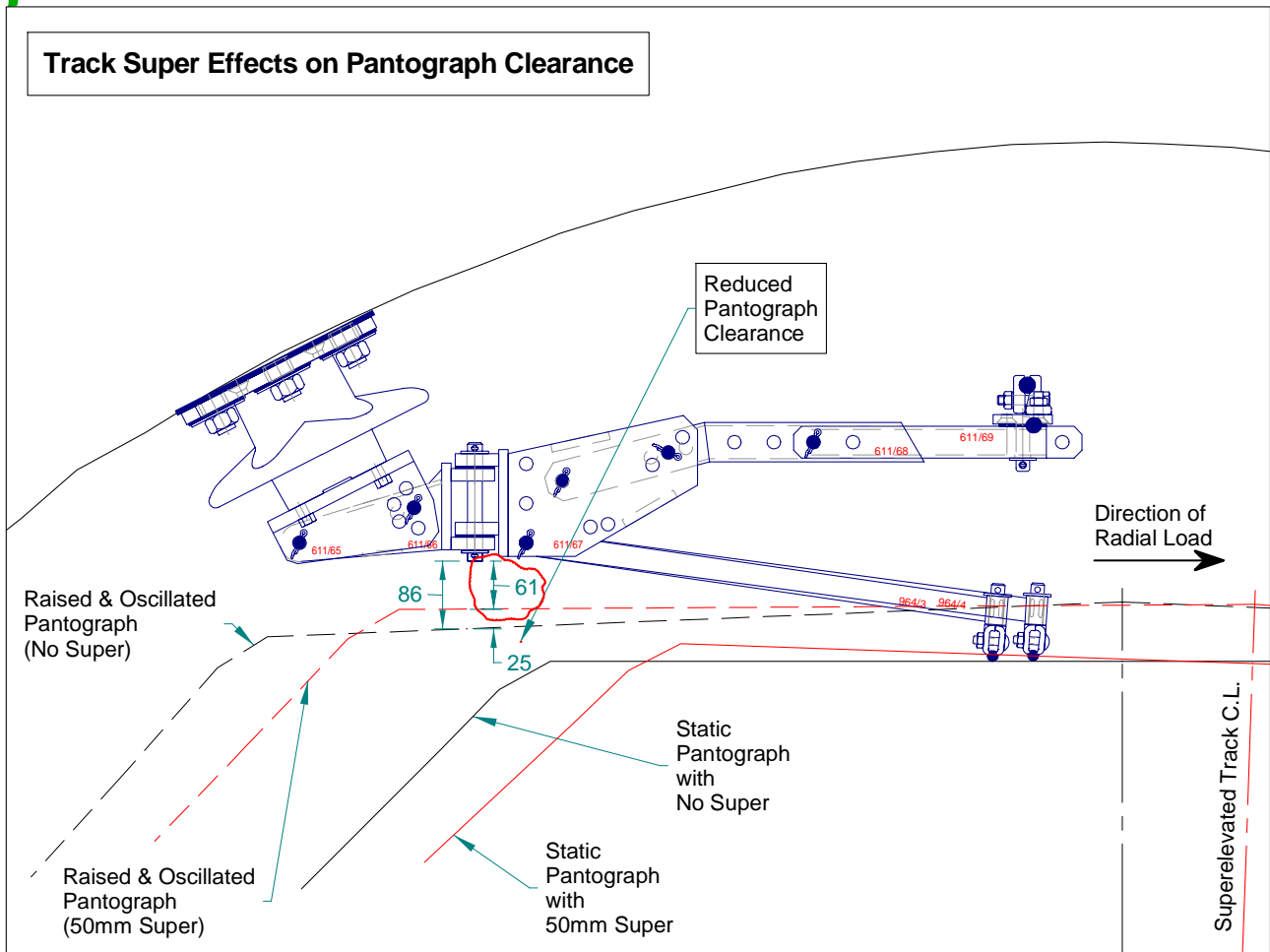

**Figure 22 - Reduced Pantograph Clearance With Track Superelevation**

- j) **Arm Selection.** To reduce Contact uplift, the shortest arms should not be used in conjunction with high radial loads.  
**Reason:**  
 The longer the arm, the less the Contact uplift. This is a consequence of the turning moments about the pin in the arm, produced by the various forces and corresponding perpendicular distances. Refer to *Figure 19*.
- k) **Contact Stagger.** Where practical, Stagger is to be positive (on the Heel-side of track superelevated centre-line).  
**Reason:**  
 A positive Stagger places the Contact wire on the same side of the pantograph as the heel of the arm. Stagger on this side helps to control any looseness and potential “tilt” on the pantograph head for this half of the pantograph. Any upward tilt would likely be on the remote half of the pantograph. Refer to *Figure 23*.



Reference material - for information only

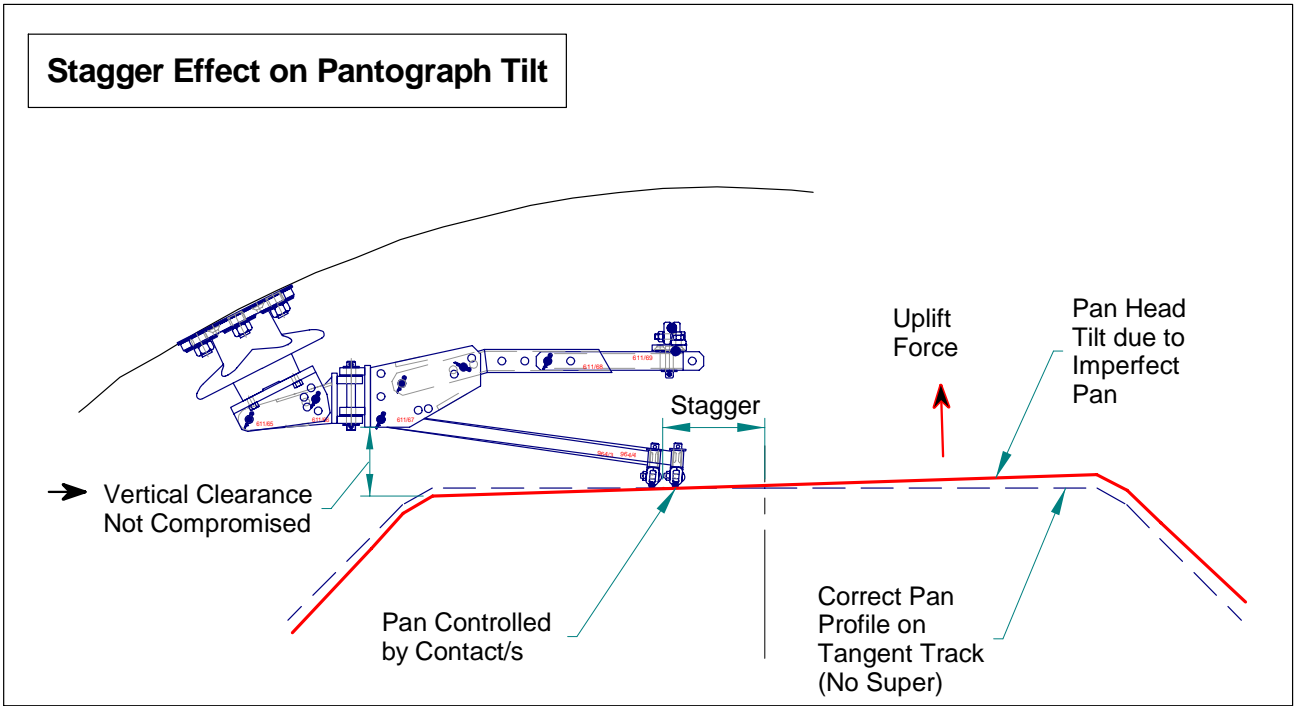

Figure 23 - Stagger Can Help Control Effects of Pan Tilt



### 7.3. Strength Checks

The new Mk-3 Tunnel Cantilever was designed by the OHW Design (Mains) group, and the proposed design along with “Loading Diagrams” representing typical worst-case scenarios at North Sydney, were submitted to Civil Design section for their assessment and strength checks.

Their modelling of the strength of the arrangement was done using “Limit State” techniques. This highlighted a couple of areas that needed improving, and this was subsequently done, resulting in sign-off by them.

Because this arrangement is based on fundamental principles and parts of previous Tunnel Cantilevers, and the strength of the arrangement was ultimately verified, it was decided that there was no need to Type Test these arrangements.

This is the same approach as that adopted with the Mk-2 Tunnel Cantilever arrangement which was developed in 2004 for the Epping and Chatswood Interface Works, as part of the Epping to Chatswood Rail Line (“ECRL”) project. The argument then was that when a bridge is designed it is not Type Tested to destruction, for to do so would be extremely expensive and ultimately unnecessary (unless there was some fundamentally new approach or material or the like involved that needed proving). The OHW loads imposed on the new Tunnel Cantilever are highly predictable, the arrangement is similar to previous models that have proven their performance over many decades (in some cases), and the extreme loads have been modelled using sophisticated software and techniques – there should be no need to “proof load” these arrangements.

Two new Mk-3 Tunnel Cantilevers were fabricated and brought to Strathfield Electrical Construction Depot in 2012, to get a “feel” for how they were to be installed, to look at their adjustability provisions, and to basically ensure there were no salient problems preventing their roll out. This proved a useful exercise, and it demonstrated the versatility of the arrangement to Construction staff. Refer to Figure 24.



Figure 24 - Checking Out the Prototype at Strathfield Construction Depot

Reference material - for information only

## 8. Installation Guide

The Mk-3 Tunnel Cantilever comes with a large degree of adjustability, to try to ensure that there can be some adjustment during installation should some need arise in the tight confines of the tunnel.

The sequence of installation is important in order to set it correctly and provide some degree of future adjustment if needed during its life.

### 8.1. Location of Tunnel Bracket

This tunnel cantilever arrangement must be installed at the correct level above track – this is important. The resulting Stagger / Pull-Off Arm configuration is of less importance (though it's still necessary for a practical solution).

The design for a particular location should require the Mounting Plate (Item 1) to be installed at a certain height above the design rail level, and this level should be shown on the design cross-section drawn for that location. Refer to *Figure 34* for an example of a Cross-Section showing the level of detail required to specify the Mk-3 Tunnel Cantilever for construction.

The level of the centre of the bracket should be surveyed and marked in the field, then the various anchor bolts marked and installed so that the centre of the bracket is installed to line up exactly with this mark. Also the top edge of the bracket is to be installed horizontal (use spirit level to confirm).

If this is done correctly (at the right height), then the remainder of the Tunnel Cantilever installation is relatively straight forward.

### 8.2. Parts "A" & "B"

This Tunnel Cantilever can be separated into 2 main assemblies as shown in *Figure 25*:

- Part "A" - The Wall Mounting Plate, Insulators and Adjustment Plate, and
- Part "B" - The "Live" cantilever that directly supports the conductors (ie. the remainder of the Tunnel Cantilever).

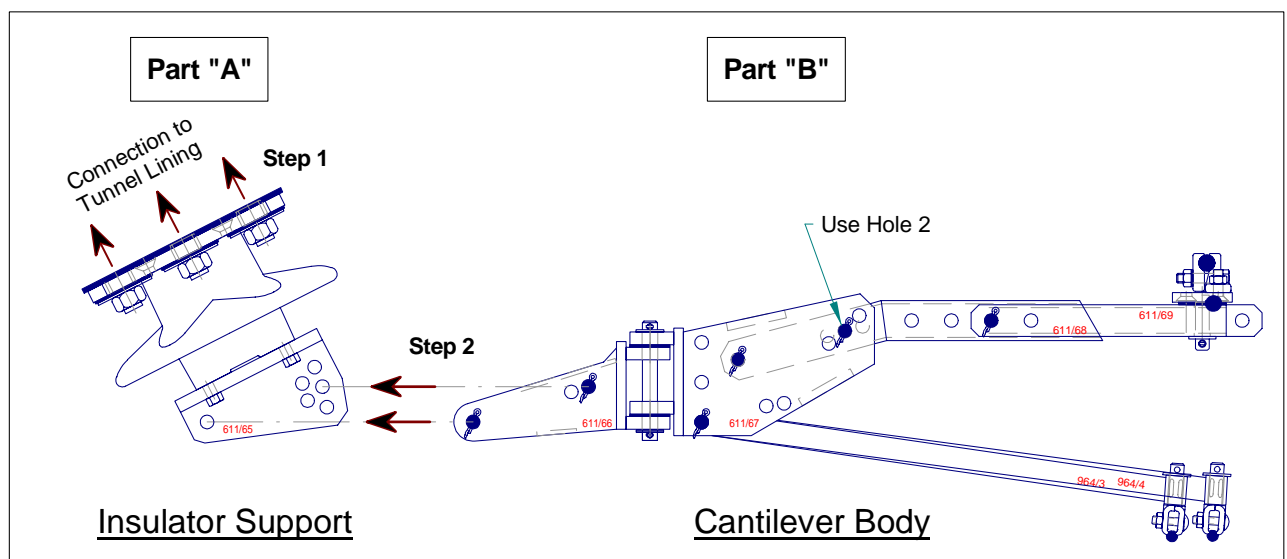

Figure 25 - Parts "A" & "B" of the Mk-3 Tunnel Cantilever

### 8.3. Installation Sequence

#### Preparation.

#### Part “A”

Firstly, Part “A” needs to be installed onto the wall – this is “**Step 1**” shown in *Figure 25*.

It is really important that the Mounting Plate (Item 1) be installed at the correct height – if it’s not then it may have to be re-installed at the correct height (there’s not a lot of latitude for error here, which unfortunately is consistent with the tight confines of the tunnel).

Part “A” consists of the Mounting Plate (Item 1), the attached 2 post-type insulators (Item 2) and the Insulator Adjustment Plate (Item 3). These insulators are attached to the Mounting Plate using 8 x 12mm stainless steel counter-sink set screws. An 8mm hex key is required to tighten these to “Snug Tight” to ensure they do not come undone over time. (They will be trapped & can only be tightened at a later date by removal of the entire plate, which is obviously extremely awkward once the cantilever is loaded with the OHW conductors).

There are 6 x 24mm diameter stainless steel threaded rods pre-installed in the tunnel lining for attaching the steel Mounting Plate. Follow the installation instructions provided by Civil Design for these threaded rods. See Appendix “C” for the Civil Design drawing showing the arrangement.

Install the plastic secondary insulation plate, then the steel plate, then install each plastic ferrule along with its oversize steel washer, spring washer and finally the stainless steel nut, onto each threaded rod.

Note that there may need to be one or more stainless steel washers acting as shims (in 0.5mm and 2mm thickness combinations) installed as required in the gap between the lining and insulation plate prior to finally tightening the plate to the wall (see Civil Design instructions). The nuts should be installed to firmly secure the plate assembly in place, but they must not be over-tight, as it’s tightening against plastic. Refer to Note 6 on Civil Drawing CV 0518429 in Appendix “C”.

The Insulator Adjustment Plate (Item 3) simply attaches to the 2 post-type insulators using the standard M12x40mm hex head set screws with spring washers.

Ideally the bottom edges of the Insulator Adjustment Plate should be surveyed to locate its exact position, and this information provided back to Design for confirming the rest of the details on the Cross-Section drawing for that location. This will help get the precise adjustment details confirmed for Construction.

Note: Once surveyed, depending on the available pantograph clearances to this fitting, the assembly may need to be removed until later needed for running new wire. Refer to *Section 10* on “Risks” for the reasons.

If the arrangement is removed, ensure the exact combination of shim washers remains intact (maybe taped to the steel plate), so that it goes back with exactly the same placement when re-installed with no need for another survey.

#### Part “B”

#### Pre-Installation Sequence.

**Refer to Appendix “A” for the Standard Arrangement drawing**

#### Before installing the arrangement onto the tunnel wall (eg. at the construction depot) :

- a) Install the External Tube (Item 6) into the Main Support Frame (Item 5).  
Ensure the 16mm stainless steel pin for Catenary Height adjustment is in Hole 2 (of 3), as shown in *Figure 25*.
- b) Install the gunmetal Catenary Clamp/s (Item 16), with the correct orientation, onto the Catenary Support Swivel Plate (Item 10).  
Secure each in place with the 2 stainless steel counter-sink screws – a spring washer and nut secures the clamp in place.  
An 8mm hex key is required for tightening the counter-sink screws.  
The correct orientation of Catenary Clamp is shown in *Figure 26* – for Single Contact in particular, the main body of the clamp is to be placed on the track side to take the Radial Load on the Catenary wire.
- c) Install the assembled Catenary Support Clamp Plate onto the correct Internal Tube (Item 7) – either the “Short” tube (Fitting 611/69) or the “Long” tube (Fitting 611/70) – check with the relevant location Cross-Section for the relevant fitting.

Reference material - for information only



Make sure there is one Blue and one White PTFE washer (Items 17 & 18) inserted on the 19mm stainless steel shaft, with these washers located between the under-side of Swivel Plate and the upper surface of the Internal Tube.  
 The bottom of the 19mm stainless steel shaft is to have a stainless steel washer and then a 6.3mm stainless steel split pin (not the hump back split pin) installed to trap the swivel assembly.

- d) Insert the assembled Internal Tube into the External Tube (Item 6), and secure in place with 16mm pin into the correct hole (as shown on the relevant location Cross-Section).
- e) Make the hinged connection of the Support Pivot Plate (Item 4) with the assembled Main Support Frame (Item 5). It is important that the bearing surfaces of Item 5 are on top of Item 4, with a pair of Blue & White PTFE washers (Items 17 & 18) between each of the 2 bearings. Install the 19mm Pivot Pin (Item 13), and trap this pin using a 6.3mm stainless steel split pin (not the hump back split pin) installed at both ends of the 19mm pin.
- f) Install the “Swing Stop” fitting (Item 27 in Standard Arrangement) and tie it in place temporarily with a plastic cable tie or rope so that the cantilever cannot swing, allowing the Catenary wire can be properly run.
- g) Install Heel Adjuster (Item 23) if required at this location. It needs to be installed in either the top pair of holes of the bottom pair. See Cross-Section drawing for all details here.
- h) It may be useful to also install the Pull-Off Arm/s (Items 8 & 9), connected at the Heel end with the 16mm pin. Temporarily tie these arms to the External Tube using rope or strong plastic cable ties.

**After Part “A” has been installed onto the tunnel lining :**

1. Raise Part “B” assembly and connect to Part “A” – this is “**Step 2**” shown in *Figure 25*. Connect the 2 parts using the 2 long 16mm stainless steel pins (Item 12) – firstly one pin installed at the pivot holes and then the other in one of the 5 adjustment holes so that the top surface of the External Tube is closest to being horizontal. (The holes each provide 5° of rotation, so the maximum error should be 2.5° from horizon). Use an electronic spirit level to measure and confirm this as being horizontal. This must be done with Catenary Height Adjustment using Hole 2 (of 3), and before the Catenary wire is run.
2. Install the “Ginny Wheel” on the hole provided at the end of the Internal Tube (Item 7), using a standard shackle (fitting 66/8). Refer to *Figure 27*.
3. When the Catenary has been run, super-tensioned and set at its appropriate “No-Load” tension (for the current temperature), transfer it up from the Ginny Wheel into the correctly orientated Catenary clamp (Item 16) and tighten this clamp – for correct orientation refer to *Figure 26*. Remove the Swing Stop fitting when required to free up the cantilever for Regulated OHW.
4. When the Contact wire/s have been run, attach to the pull-off arm/s via their Contact Swivel Clamps (Item 11).

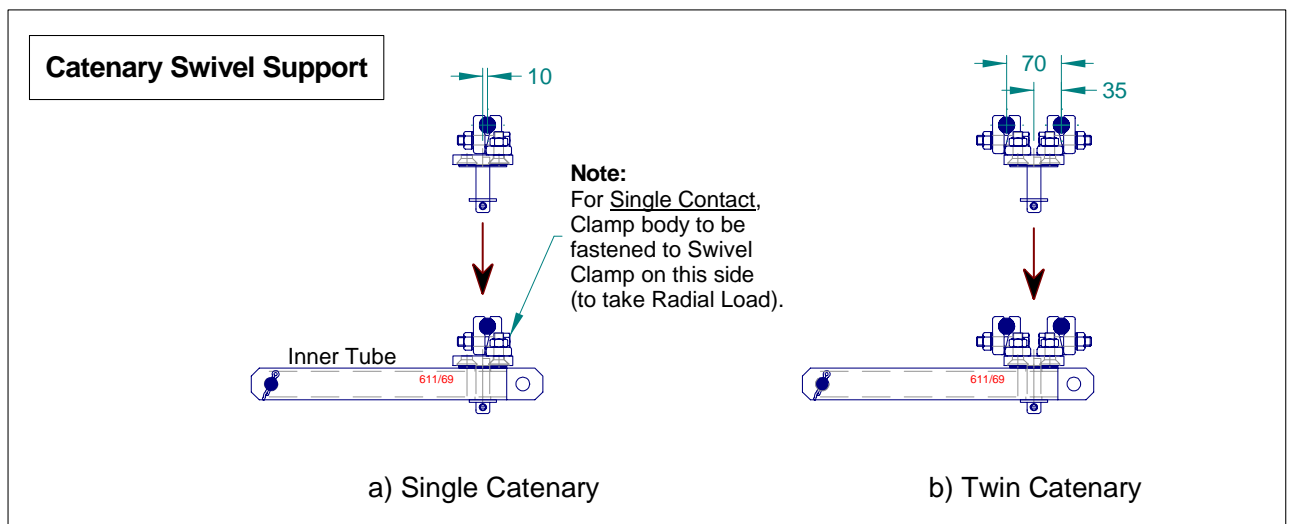

**Figure 26 - Correct Orientation of Catenary Bridge Clamp on Swivel**

Reference material - for information only

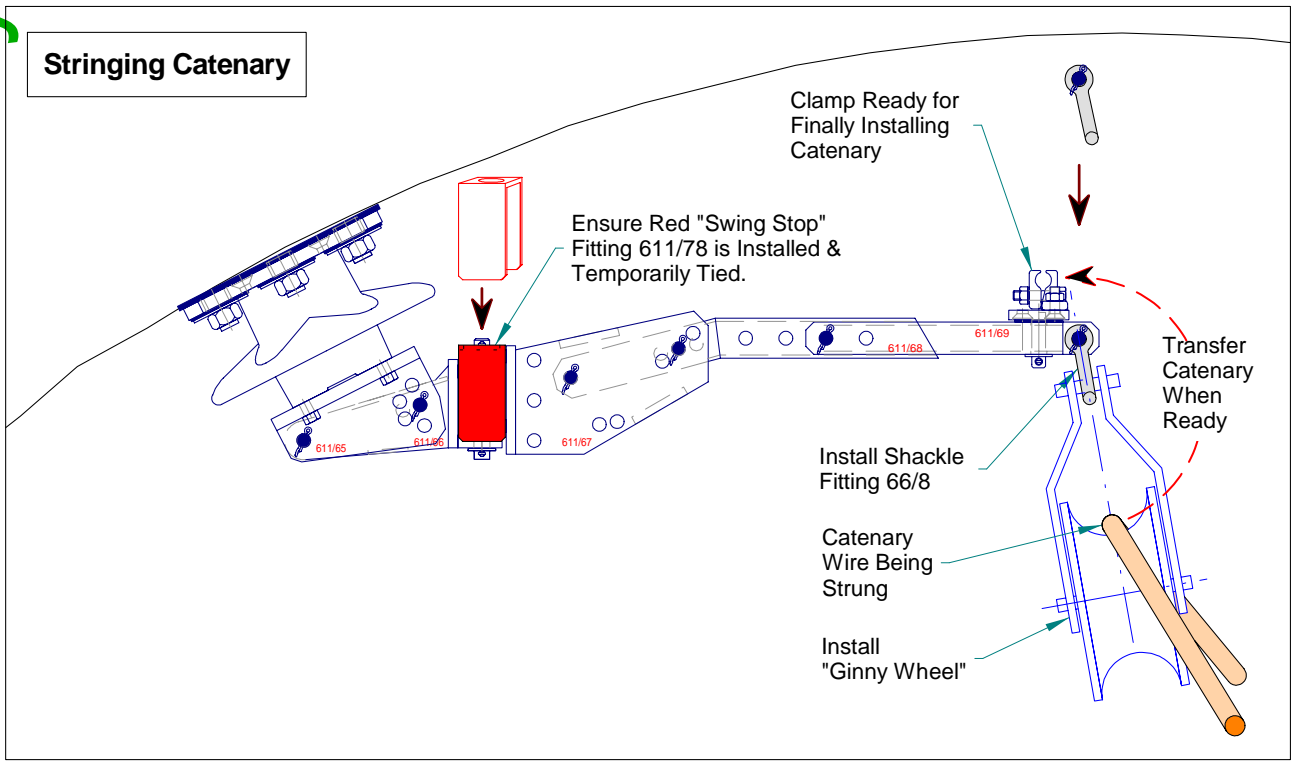

Figure 27 - Preparing the Tunnel Cantilever for Stringing the Catenary Wire

## 8.4. Adjustments

The Tunnel Cantilever should be installed as detailed in the design cross-section for that location, which should ideally have been based on as-built survey of installed “Part A” in *Figure 25*. (Be careful of the risks in doing this, as detailed in *Section 10*).

If adjustments are required, this is relatively straight forward, as mentioned in *Section 6* “Adjustability Provisions”. However, the following aspects should be considered.

### a) Effect of changing Catenary Height on Contact Height and Heel Height.

*Figure 28* shows the general effect on Catenary height if using the 3-Hole Catenary Height adjustment, and more importantly how this can affect the Contact height and Heel height if the droppers are not adjusted in the adjacent bays.

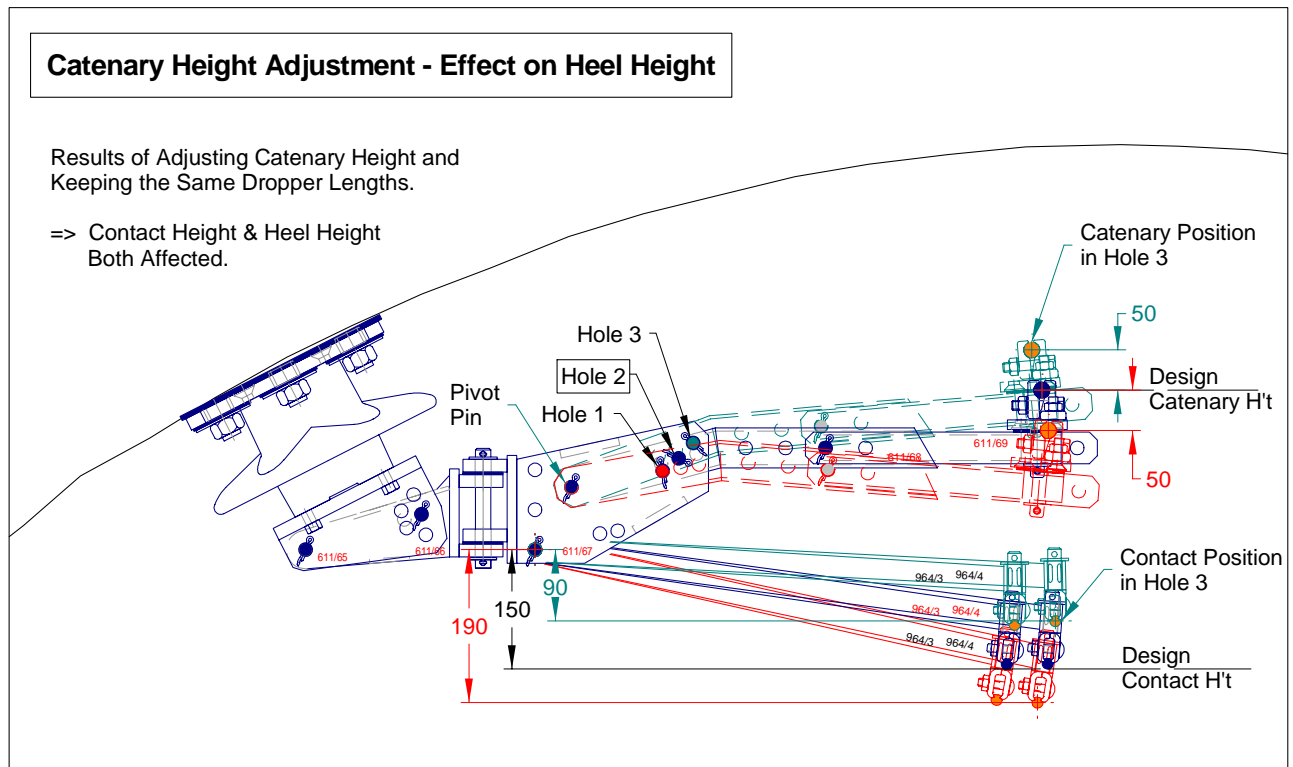

**Figure 28 - How Changing Catenary Height Can Affect Contact Height & Heel Height**

*Figure 29* shows the general effect on Catenary height if using the 5-Hole Adjustment (which is intended for getting the External Tube to be horizontal when setting up). This is not the preferred adjustment method, but may be required if other things don't appear to work. The Figure shows that the droppers need to be adjusted to get back to the design Contact height.

This approach may have some benefit, for instance, if you use 1 hole higher (of the 5) to raise the Main Support Frame (Item 5) and thus get more pantograph clearance to the under-side of the Tunnel Cantilever. However the droppers may need adjustment for the correct Contact height, and the Heel height clearance would need to be checked out.



Reference material - for information only

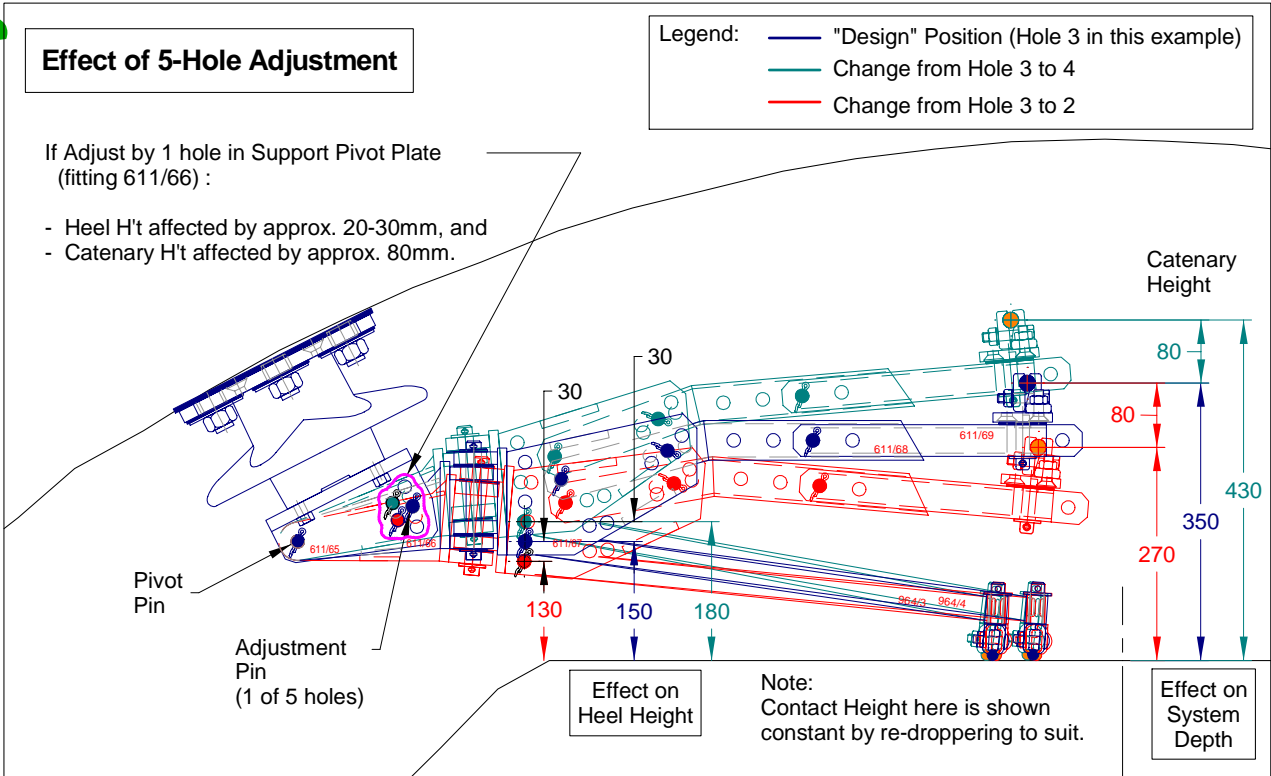

Figure 29 - Effect of Using 5-Hole Adjustment on Catenary & Heel Heights

## 9. Integrated Support Requirements

The new Mk-3 Tunnel Cantilever has been given the following Technical Maintenance Code (TMC) :

**EP 08 11 79 00.**

### 9.1. Maintenance Requirements

#### a) Maintenance Requirements Analysis (MRA)

Apparently this is the new term for what used to be called the Failure Modes, Effects and Criticality Analysis (FMECA).

Because the new Mk-3 Tunnel Cantilever was based on previous types which had been previously analysed in the 1990's and 2004, it was relatively straight forward to detail the failure modes of this new piece of equipment.

There were basically no surprises, and therefore the maintenance requirements should be similar to the previous generations of Tunnel Cantilevers.

Refer to Appendix "C" for the output of the MRA analysis results.

#### b) Service Schedules

Refer to Appendix "D".

#### c) Technical Maintenance Plan

Refer to Appendix "E".

### 9.2. Spares Support

Some of the parts of the new Mk-3 Tunnel Cantilever are standard items used in other Support & Registration arrangements in the electrified network. This includes:

- Post-Type Insulator – Fitting 452/10 (Item 2)
- Catenary Clamp – Fitting 187 (Item 16)
- Contact Swivel Clamp – Fitting 61/2 (Item 11)
- 16mm Stainless Steel Pins – Fittings 511/32, 511/67, 511/77

The remainder of the parts are newly developed fittings (that may be available for other arrangements in future).

Any spare parts should therefore be focussed on the newly developed parts.

Alternatively, the complete Tunnel Cantilever assembly could be kept as spares. At North Sydney the number of Mk-3 Tunnel Cantilevers required per track is as follows:

- Up Shore – 5 off
- No. 2 Road – 5 off
- No. 3 Road – 5 off
- Down Shore – 8 off

Based on this, it could be argued that 5 complete cantilever arrangements is the most practical number to keep as spares.

### 9.3. Operations & Maintenance Manuals

It is envisaged that the contents of this document in part be incorporated into the OHW Equipment Manual.

### 9.4. Training

If staff become au fait with the functionality of the Mk-3 Tunnel Cantilever by reading this document and also having some “hands on” familiarity, then it is not expected that any further training be needed beyond their normal Mains training. If the Operation & Maintenance Manual (above) has been developed it would be an obvious source of such training.

The most difficult thing about this arrangement is understanding the degree of adjustability provided, and knowing how it works. Provided this is understood, the rest of the arrangement should be relatively straight forward.

### 9.5. Support Equipment & Tooling

The new Mk-3 Tunnel Cantilever has been modelled on previous OHW Tunnel Cantilevers installed in the Electrified Network dating back 10 years (Mark-2) and more than 25 years (Mark-1).

The technology and parts are well established.

This new arrangement brings many improvements to the previous models, and is especially adapted for the tight space available in a single track “Bread loaf” shaped tunnel, although its use can be extended to other tunnel shapes with care.

As such, there are little extra support equipment and tooling requirements over that of previous Tunnel Cantilever equipment.

#### Support Equipment

In future, if the Cantilever is to be renewed or its 2 insulators replaced, it will likely be necessary to support the Catenary wire. This may be achieved using the hydraulic boom of the OHW vehicles, or by some other convenient means that can be determined at the time.

#### Special Tools

The following is a list of special tools:

- 8mm hex Allen key – for tightening the special stainless steel counter-sink set screws that attach :
  - a) The steel “Mounting Plate” (Item 1) to the post type insulators (Item 2) - 8 set screws required, and
  - b) The “Catenary Clamp” (Item 16) to its “Catenary Support Swivel Plate” (Item 10) - 2 set screws required.

## 10. Risks

The main risk to the reliability of this arrangement seems to be insufficient pantograph clearance to the Tunnel Cantilever arrangement. As described previously, this can come about by insufficient Heel height (which is required for vertical clearance to the pantograph below).

### Main Cause

Upgrading an existing Fixed-Anchored OHW system to regulated using this Tunnel Cantilever arrangement requires special care, especially in regard to the pantograph clearances if the mounting bracket and insulator hardware are installed. Fixed-Anchored OHW normally suffers badly with low Contact height problems in tunnels, and its design usually tries to work around this problem by providing a higher Contact height wherever this is practical (at the expense of reduced pantograph diagonal clearance to tunnel lining).

Special care must be exercised when staging the conversion from Fixed-Anchored to Regulated OHW equipment as the higher F/A Contact height may lead to collision of pantograph with the post-type insulator support and especially the Insulator Adjustment Plate (Item 3) if this **Part "A"** is left installed. See Figure 30.

It is critical to properly assess clearances in this situation and take the necessary staging action before the Regulated OHW is finally in place.

Note that in some areas of the Twin Track Tunnels, the existing relatively high OHW Contact height of the old Fixed-Anchored OHW is currently causing significant electrical infringements from pantograph to tunnel lining. Ideally the Contact height should come down, but it's probably been raised at some stage in the past to prevent the Contact wire from sagging onto the top of a train under extremely hot conditions (which has happened a number of times recently on the Up Shore track in the Single Track Tunnel).

This is one of the main drivers for Regulating the OHW through these tunnels, and in doing so, it will also correct the existing non-compliant pantograph clearance to the tunnel lining (by lowering the Contact wire and keeping it at the contact level (regardless of temperature)).

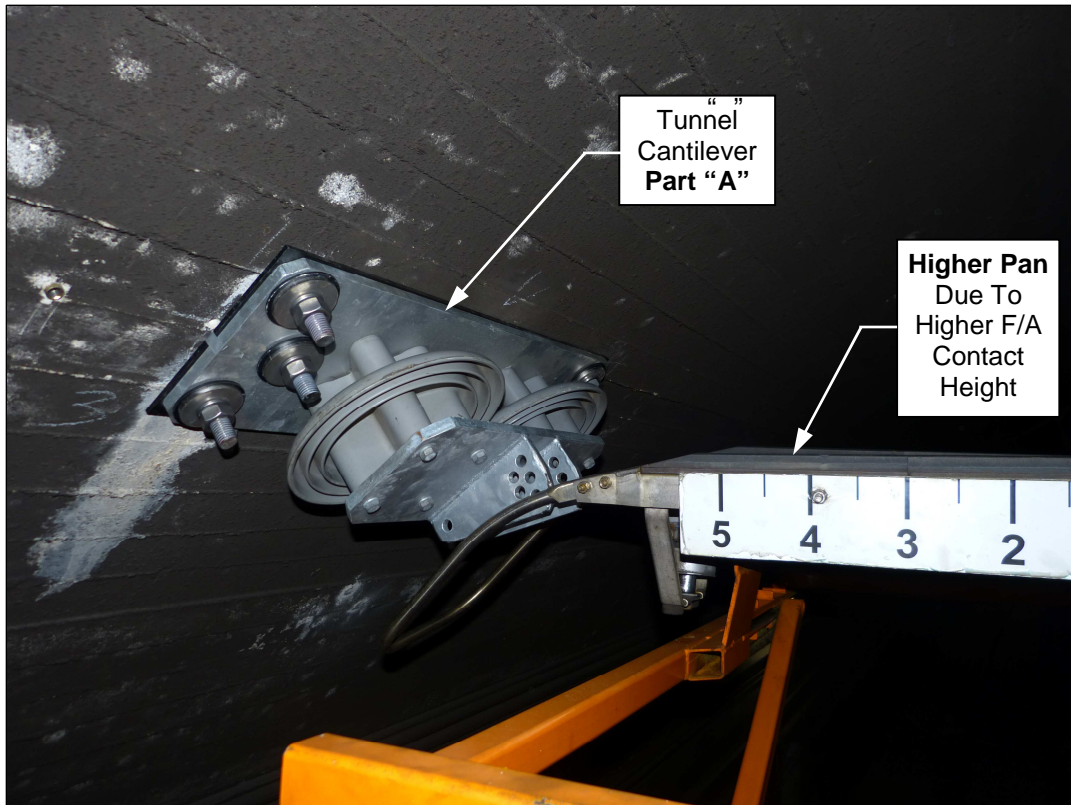

Figure 30 - Pantograph Clash with New Cantilever Fittings (Fixed-Anchored OHW)

Reference material - for information only

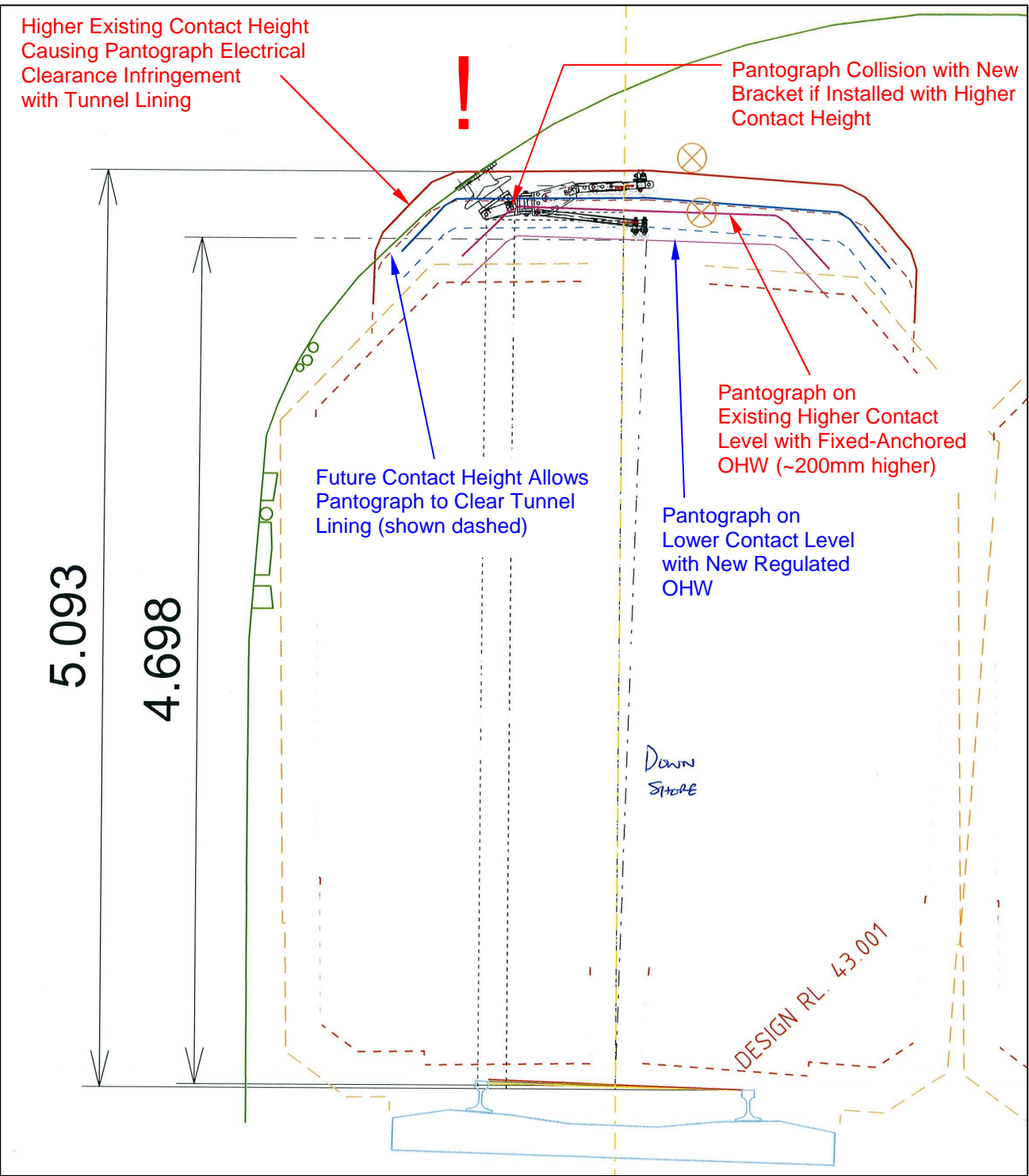

Figure 31 - Potential Problem Staging with Fixed-Anchored OHW



## 11. Quality Assurance Inspections & Handover

After the Tunnel Cantilever has been built, the following QA items should be undertaken:

- **Insulators :**
  - Check bolts for tightness and that the insulators are firmly seated on the Mounting Plate.
  - Ensure that there is no conductive object shorting out the insulation.
  - Check plastic insulators for signs of damage (cracked skirts, hair-line cracks near screw inserts, etc.).
- **Electrical Clearances :**
  - Measure the shortest diagonal clearance from Catenary wire to the Tunnel Lining (must be > 150mm).
- **External Tube :**
  - Check that the tube is installed in Hole 2 (or 3).
  - Measure & record the incline on the External Tube – to be horizontal (level  $\pm 2.5^\circ$ ).
- **Catenary Swivel :**
  - Check that the pair of Blue & White Thrust Washers (Items 17 & 18) are installed between Swivel Plate and Internal Tube.
- **Stainless Steel Pins :**
  - Check that the pins are fully inserted & split pins are properly installed at both ends.
- **Main Hinge Connection :**
  - Check that the Main Body tongues (Item 5) is installed on top of the Support Pivot Plate tongues (Item 4) in the hinge.
  - Check that the pair of Blue & White Thrust Washers (Items 17 & 18) are installed between both pairs of hinge tongues.
  - Check that the “Swing Stop” fitting (Item 27) is removed.
  - Check the top & bottom Split Pins are 6.3mm (not hump-back) and ends are bent back for security.
- **Heel Height (EXTREMELY IMPORTANT):**
  - Measure & record Heel height - must be to design  $\pm 25$ mm.
  - Also ensure that it is more than 100mm & less than 200mm.
- **Contact Stagger :**
  - Measure & record the Contact Stagger (to be within  $\pm 25$ mm of Design value).
- **Contact Height :**
  - Measure & record the Contact Height (to be within  $\pm 25$ mm of Design value).
- **Along-Track Position :**
  - Check that the Swing of the tunnel cantilever is consistent with the current temperature (must be perpendicular to track at 25°C). Refer to Chart in Appendix “H”.



Figure 32 - Tunnel Cantilever Inspections

Reference material - for information only



## 12. Conclusion

Various constraints & issues for a single-track Tunnel Cantilever have been discussed in this report, and an argued response & solution have been provided.

Various adjustments are included in the design to cater for local imperfections during construction. Whilst trying to keep the actual design as simple as practical, it is hoped that these adjustment provisions won't make the fabrication & understanding of the Tunnel Cantilever arrangement too difficult in practice.

This Tunnel Cantilever arrangement is not suitable for Fixed Anchored OHW, because of the wild conductor tension changes with temperature and its consequences on Heel heights and pantograph clearances.

However, the various big benefits of regulated OHW should allow this new Tunnel Cantilever arrangement to perform as intended without problems.

Figure 33 shows a series of Mk-3 Tunnel Cantilevers installed around the reverse track bends immediately north of North Sydney Station for the Up Shore track. This new wire was installed in 2013.

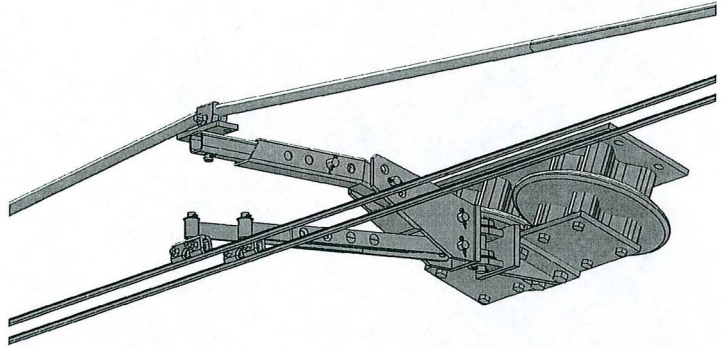

Prior to the renewed Regulated OHW, this was the site of numerous “Low OHW” problems that have occurred with the old Fixed-Anchored OHW system over the past several decades, with the most recent critical train service interruption occurring in about 2009, affecting peak hour services.

The problem has been that the tunnel profile is so tight that the old Fixed-Anchored OHW, under hot conditions and with increased train electrical power loading, had drooped (sagged) so low as to touch the top of double-deck trains, which stopped trains until it cooled down.

Regulating the OHW totally overcomes the OHW droop problem with temperature, and the new Mk-3 Tunnel Cantilever was developed to allow Regulated OHW to be installed in this situation. It is the necessary solution to the long-term problem that has plagued this area.

Document Prepared By:

Ken FitzGerald (BE, MEngSc)

22/8/2013

Technical Specialist, Mains  
Electrical Design - Sydney Trains

Endorsed:

23-8-2013  
Principal Engineer Mains

Approved:

23/8/2013  
Head Engineer Electrical ASA



Reference material - for information only



Figure 33 - Mk-3 Tunnel Cantilevers Supporting OHW Around Reverse Trackwork



## **Appendix “A” - Tunnel Cantilever Standard Arrangement Drawing**

The standard arrangement for the Mk-3 Tunnel Cantilever is on drawing EL 0357173, which is shown on next page.

Reference material - for information only



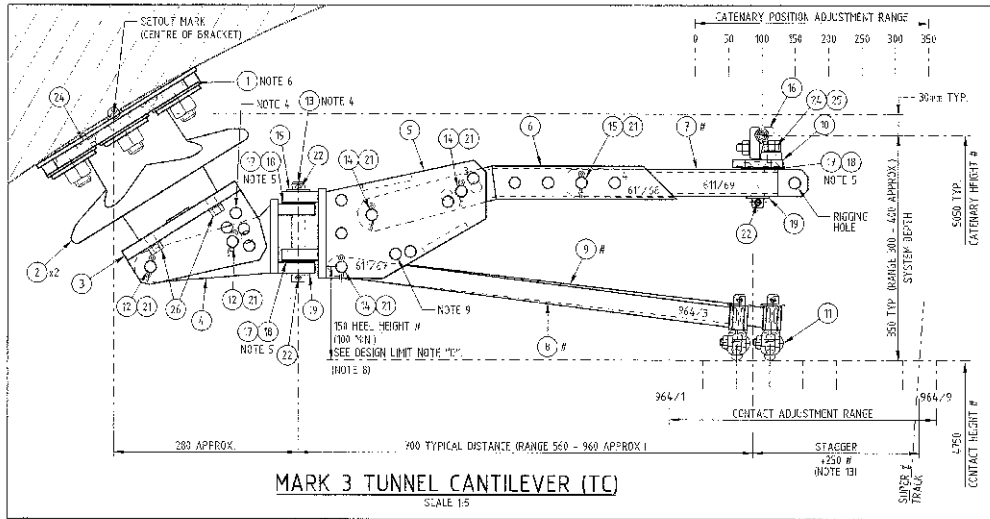

**DESIGN LIMITATIONS:**

- A. TENSION MODE: FOR USE WITH REGULATED OHW ONLY.
- B. TENSION LENGTH: TUNNEL CANTILEVER TO BE LOCATED WITHIN 500m OF FIXED ANCHOR OR FIXED MID-POINT LOCATION DUE TO LIMITED CANTILEVER SWING WITH TEMPERATURE.
- C. WIRE LOADING: TOTAL CONTACT LOAD (RADIAL + WIND) LIMITED TO 15kN FOR TWIN CONTACT & 12kN FOR SINGLE CONTACT, SUBJECT TO UPLIFT CONSIDERATIONS. RADIAL LOAD SHOULD BE POSITIVE (ACTING AWAY FROM SUPPORT INSULATORS). ANY COMPRESSION LOAD IS TO BE LESS THAN 200N PER WIRE.
- D. HEEL HEIGHT: DESIGN HEEL HEIGHT OF 150mm IS CRITICAL IN THIS DESIGN TO ENSURE SUITABLE PANTOGRAPH CLEARANCE (ACTUAL HEEL HEIGHT IS NOT TO BE LESS THAN 100mm). TO LIMIT PANTOGRAPH UPLIFT, HEEL HEIGHT SHOULD NOT EXCEED 200mm.
- E. CONTACT UPLIFT: DESIGNER MUST DETERMINE HOW MUCH THE CONTACT WIRE LIFTS WITH RAMPA, 1 (N) AND PANTOGRAPH UPLIFT PRESSURE, AND ENSURE SUITABLE HEEL HEIGHT IS CHOSEN. HIGHER RADIAL LOADS MAY NOT BE SUITABLE. DAY LENGTHS TO BE LIMITED TO 30m MAX IN THE DAY BEFORE & AFTER THE ARRANGEMENT.
- F. CONTACT RAMP RATE: IDEALLY TO BE ZERO IN THE DAY BEFORE & AFTER THE ARRANGEMENT 11,1000 MAXIMUM.
- G. TRACK SPEEDS: SHALL BE UP TO APPROX 50km/h, UNLESS DETERMINED OTHERWISE.
- H. TRACK SUPERELEVATION: HIGH SUPERELEVATION (TYP > 100mm) MUST BE TAKEN INTO ACCOUNT WHEN DETERMINING THE MINIMUM HEEL HEIGHT (DUE TO REDUCTION IN PANTOGRAPH CLEARANCE TO UNDERSIDE OF PULL-OFF ARRANGEMENT AND BOTTOM OF PIVOT PIN ITEM 13).

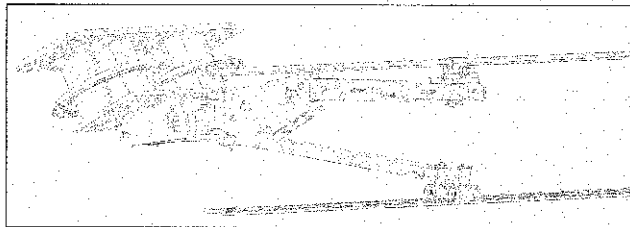

**REGULATED OHW SYSTEMS**

CONFIGURATION	CATENARY		CONTACT		SYSTEM WEIGHT
	SIZE	TENSION	SIZE	TENSION	
OHW SYSTEM 2	27mm <sup>2</sup>	20kN	2 x 15mm <sup>2</sup>	2 x 17.5kN	31 N/m

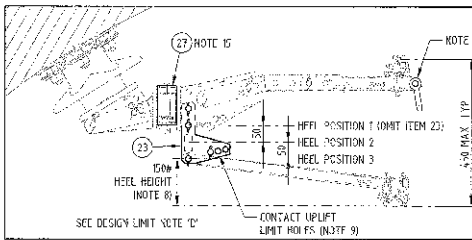

**ARRANGEMENT WITH HEEL ADJUSTER**

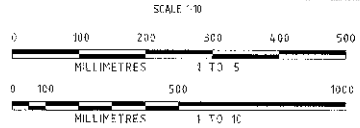

**NOTES:**

1. THIS ARRANGEMENT IS DESIGNED FOR USE IN THE SINGLE TRACK "BREADLOAF" TUNNELS AT NORTH SYDNEY (WITH LIMITED HEADROOM).
2. ARRANGEMENT IS FOR USE WITH REGULA OHW ONLY (WHICH GIVES LIMITED CONTACT UPLIFT WHEN PANTOGRAPHS PASS).
3. TWO FIRST TYPE INSULATORS (ITEM 2) ARE ATTACHED TO THE MOUNTING PLATE (ITEM 1) USING 4. COUNTERSUNK SOCKET SCREWS WITH 8mm HEX NUTS. REFURBS REFURBS THE USE OF AN 8mm HEX ANCHOR KEY SOCKET FOR INSTALLATION. SPLITTING TORQUE IS 25Nm.
4. ENSURE MAIN 19mm PIVOT PIN (ITEM 13) IS INSTALLED VERTICAL. FIVE LEVELS OF INSULATOR ADJUSTMENT ARE PROVIDED (ITEMS 7 & 8) TO ADJUST FOR VERTICALITY OF THIS PIN.
5. ONE BLUE AND ONE WHITE THRUST WASHER (ITEMS 17 & 18) TO BE INSTALLED BETWEEN BOTH POINT BINDING SURFACES (ITEMS 4 & 5) AT MAIN PIN (ITEM 13), AND UNDER CATENARY SUPPORT SWIVEL PLATE (ITEM 16).
6. FOR INSULATOR PLATE MOUNTING DETAILS IN TUNNEL WALL REFER TO CIVIL DRAWING CVC618-29. INSULATING PLATE & 6 INSULATING FERRULES ARE USED TO ENSURE NO STRAY DC CURRENTS CAN LEAK INTO THE TUNNEL ANCHOR BOLTS (PROVIDES SECONDARY INSULATION).
7. "M" SYMBOL MEANS THAT THE FITTING'S VARIABLES REFER TO SITE SPECIFIC CROSS-SECTION FOR ACTUAL FITTING NUMBER & DIMENSIONS TO USE AT THAT LOCATION.
8. HEEL HEIGHT CAN BE ADJUSTED USING THE "HEEL ADJUSTER" (ITEM 23). THE ADDITION OF THE HEEL ADJUSTER LOWERS THE HEEL HEIGHT.
  - 50mm USING TOP PAIR OF HOLES IN ITEM 5, AND
  - 100mm (BY USING LOWER HOLES).
  - SEE INSET "ARRANGEMENT WITH HEEL ADJUSTER".
9. PROVISION HAS BEEN MADE TO LIMIT CONTACT UPLIFT FOR HIGH RADIAL LOAD / HIGH HEEL HEIGHT COMBINATIONS. TWO STOP HOLES (LOCATED ABOVE THE PULL-OFF ARMS) ARE FOR INSTALLING A 16mm PIN (ITEM 14), AND THE ADJACENT STEEL SPACER IS A THIRD STOP. LIKEWISE THE HEEL ADJUSTER (ITEM 23) HAS 3 HOLES FOR LIMITING UPLIFT. IF USED, THE CONTACT MUST BE ALLOWED TO LIFT 50mm UNIMPEDED FROM ITS STATIC POSITION. TWIN CONTACTS TO BE SPACED 50mm APART INSIDE TUNNEL (FOR SUITABLE DRAGGING). CONTACTS ARE NUMBERED 1 & 2 FROM LEFT TO RIGHT WITH BACK TO SYDNEY.
11. A MINIMUM OF 150mm ELECTRICAL CLEARANCE MUST BE MAINTAINED UNDER ALL CONDITIONS OF WIRE MOVEMENT DUE TO CHANGES IN TEMPERATURE.
12. STANDARD ARRANGEMENT IS DRAWN & COORD WITH O&C TO SYDNEY. FOR LOADING SEE ELO51905. REFER TO "EXAMPLE OF TYPICAL CODING".
13. POSITIVE STAGGER PLACES THE CONTACT WIRES ON THE INSULATOR SIDE OF THE STALK SUPERELEVATED CENTRE-LINE.
14. "RIGGINS HOLE" (LOCATED ADJACENT TO CATENARY SUPPORT) TO BE USED FOR ATTACHING "GINNY" WHEEL TO RUN THE CATENARY DURING CONSTRUCTION.
15. "SWING STOP PLATE" (ITEM 27) TO BE TEMPORARILY INSTALLED OVER TOP END OF 15mm PIVOT PIN (ITEM 13) TO LOCK THE CANTILEVER FROM SWINGING WHEN RUNNING CATENARY WIRE.
16. ALL DIMENSIONS ARE IN mm UNLESS NOTIFIED OTHERWISE.

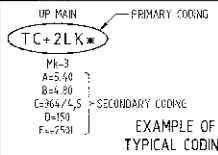

**ADJUSTABILITY**

ASPECT	ADJUSTMENT RANGE	INCREMENTAL ADJUSTMENT	ADJUSTMENT PROVISION
INSULATOR (NOTE 4)	+10°, +5°, 0°, -5°, -10°	5°	5 HOLES IN ITEMS 7 & 2 HOLES IN ITEM 4
CATENARY HEIGHT	50mm, 0mm, -50mm	50mm	3 HOLES IN ITEMS 5 & 6
CATENARY STAGGER	35.0mm (8 POSITIONS)	50mm	4 HOLES IN ITEM 6 + 2 SIZES OF ITEM 7
CANTILEV STAGGER	400mm	50mm	9 ARM LENGTHS ITEMS 3 & 8.9
HEEL HEIGHT (NOTE 8)	0mm, -50mm, -100mm	50mm	0MM ITEM 7; 2 HOLES IN ITEMS 5 & 23
CONTACT UPLIFT LIMITER	1st STOP: THEN +2° & +4°	2°	2 HOLES IN ITEM 5, 3 HOLES IN ITEM 23

ITEM	DESCRIPTION	FITTING No.	REQ'D	MAT'L	DRAWING No.
27	SWING STOP PLATE (PAINTED RED)	611/78	1	M.S.	ELO52167
26	M12x60 HEX HEAD SET SCREW WITH S.P. WASHER	-	2	M.S. Galv	COMMERCIAL ITEM
25	M12 S.S. NUT, WASHER AND S.P. WASHER	-	8	S.S.	COMMERCIAL ITEM
24	M12x60 S.S. COUNTERSUNK SET SCREW (8mm HEX INSERT)	-	19	S.S.	COMMERCIAL ITEM
23	HEEL ADJUSTER	611/73	IF REQ'D	M.S. Galv	ELO25711
22	5.3mm SPLIT PIN, 52 LONG TO A.S. 1256	-	2	S.S.	COMMERCIAL ITEM
21	SPLIT PIN #6/A TO A.S. 154 PART 2	-	AS REQ'D	S.S.	COMMERCIAL ITEM
19	WASHER 211.6, 34 O.D., 3 THK TO AS-1037	-	3	M.S. Galv	COMMERCIAL ITEM
18	WHITE THRUST WASHER	511/72	3	P.T.F.E.	ELO18905
17	BLUE THRUST WASHER	611/71	3	P.T.F.E.	ELO18905
16	27mm <sup>2</sup> CATENARY CLAMP FOR BRIDGES	187	1	S.M.	ELO22484
15	15mm S.S. PIN - 72mm LONG	211/32	1	S.S.	ELO03735
14	16mm S.S. PIN - 152mm LONG	511/67	4	S.S.	ELO03735
13	15mm PIVOT PIN - 15mm LONG	120/15	3	S.S.	ELO518225
12	16mm S.S. PIN - 127mm LONG	511/77	2	S.S.	ELO03735
11	CONTACT CLAMP ASSEMBLY	612	2	S.S.	ELO07014
10	CATENARY SUPPORT SWIVEL PLATE	6126	1	S.S.	ELO039745
9	PULL-OFF ARM	914/56	1	M.S. Galv	ELO25712
8	PULL-OFF ARM	964/18	1	M.S. Galv	ELO05712
7	CATENARY SUPPORT INTERNAL TUBE	611/69 OR 70A	1	M.S. Galv	ELO35710
6	CATENARY SUPPORT EXTERNAL TUBE	611/68	1	M.S. Galv	ELO35710
5	MAIN SUPPORT FRAME	611/67	1	M.S. Galv	ELO35710
4	SUPPORT PIVOT PLATE	611/66	1	M.S. Galv	ELO35710
3	INSULATOR ADJUSTMENT PLATE	611/65	1	M.S. Galv	ELO35710
2	POST TYPE INSULATOR	452/70	2	EPDXY	ELO07013
1	MOUNTING PLATE	613/71	1	M.S. Galv	ELO35710

This drawing and the information contained thereon have been created solely for a particular purpose and client. This is protected by copyright. You may not reproduce any of it in any form without the written permission of Rail Corporation New South Wales. If you do, you may have to pay damages to Rail Corp or you may be prosecuted.

**GENERAL**

**RAILWAYS OVERHEAD WIRING**  
**MARK 3 TUNNEL CANTILEVER**  
**ARRANGEMENT**

FILE No. F2011/14954 SHEET 1 OF 1 A2  
 STATUS: CURRENT

**ELO357173** B

A. ORIGINAL ISSUE

B. 3 THK 18 ID. 34 O.D. WASHER ITEM 24 REMOVED AND REPLACES EXTRA ITEM 18. C&S. 20/01/2011. Approved: [Signature] APPRO. 01/01/2011

REFERENCE DRAWINGS

DESIGNED: C.SJARRIDGE  
 DESIGNED: K.T.ZOBERALD  
 DRG CHECK: G.CAYALLARD  
 DESIGN CHECK: P.RIZZO W.LEUNG  
 APPROVED: N.HOOK 12.12.12

Engineering & Projects Group  
 Professional Services Division  
 ELECTRICAL DESIGN

Design accepted for use by RailCorp

## Appendix “B” - North Sydney - Up Shore Cross-Sections With Tunnel Cantilever

Appendix “B” shows early concept Cross-Section views of the proposed Tunnel Cantilever installed at the 5 support locations needed for wiring the Up Shore single-track tunnel located immediately north of the Station.

The 1<sup>st</sup> location inside the single-track tunnel will be a simple Fixed Mid-Point arrangement, and so the subsequent 5 locations (each a Tunnel Cantilever) will have to deal with only a small amount of conductor expansion & contraction with temperature (estimated at about  $\pm 60\text{mm}$  max). Note that these actual support locations may change by 1m or so during detailed design (depending on local conditions).

It should be pointed out that the resulting staggers at each location may not be ideal, but they do readily provide the necessary level of pantograph security in this area. The lack of any cross-track wind here benefits not only the pantograph security, but also minimises any stresses on the various tunnel cantilever components (for example, the Catenary & Contact wire Radial Loads remain constant on the support tubes & arms).

A close examination of the “2<sup>nd</sup> location” shows the addition of the “Heel Adjuster” in order to get the required Contact height without introducing excessive Heel height.

5 Locations:

- NS5+297 (2<sup>nd</sup> location)
- NS5+319 (3<sup>rd</sup> location)
- NS5+341 (4<sup>th</sup> location)
- NS5+365 (5<sup>th</sup> location)
- NS5+389 (6<sup>th</sup> location)

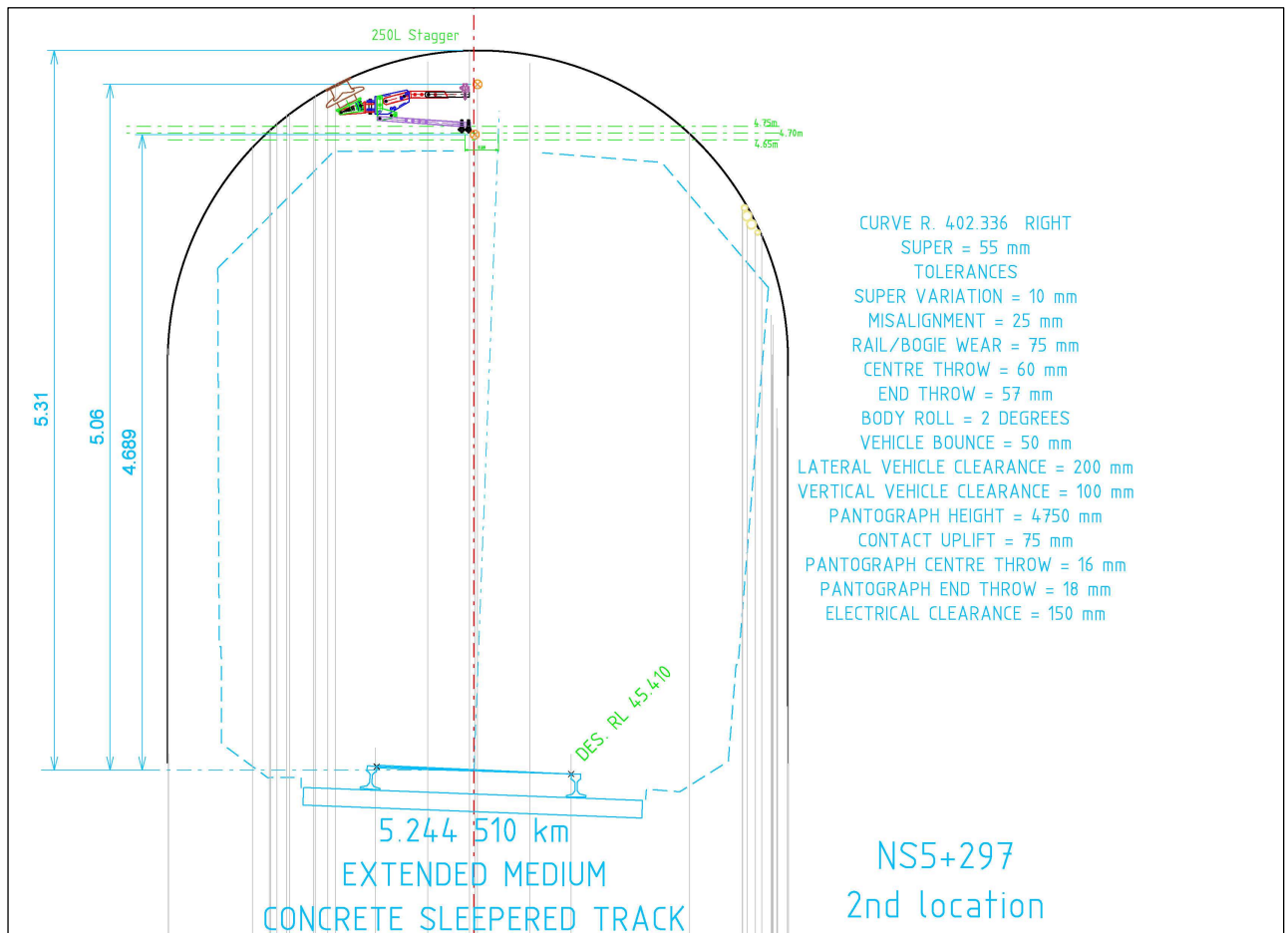

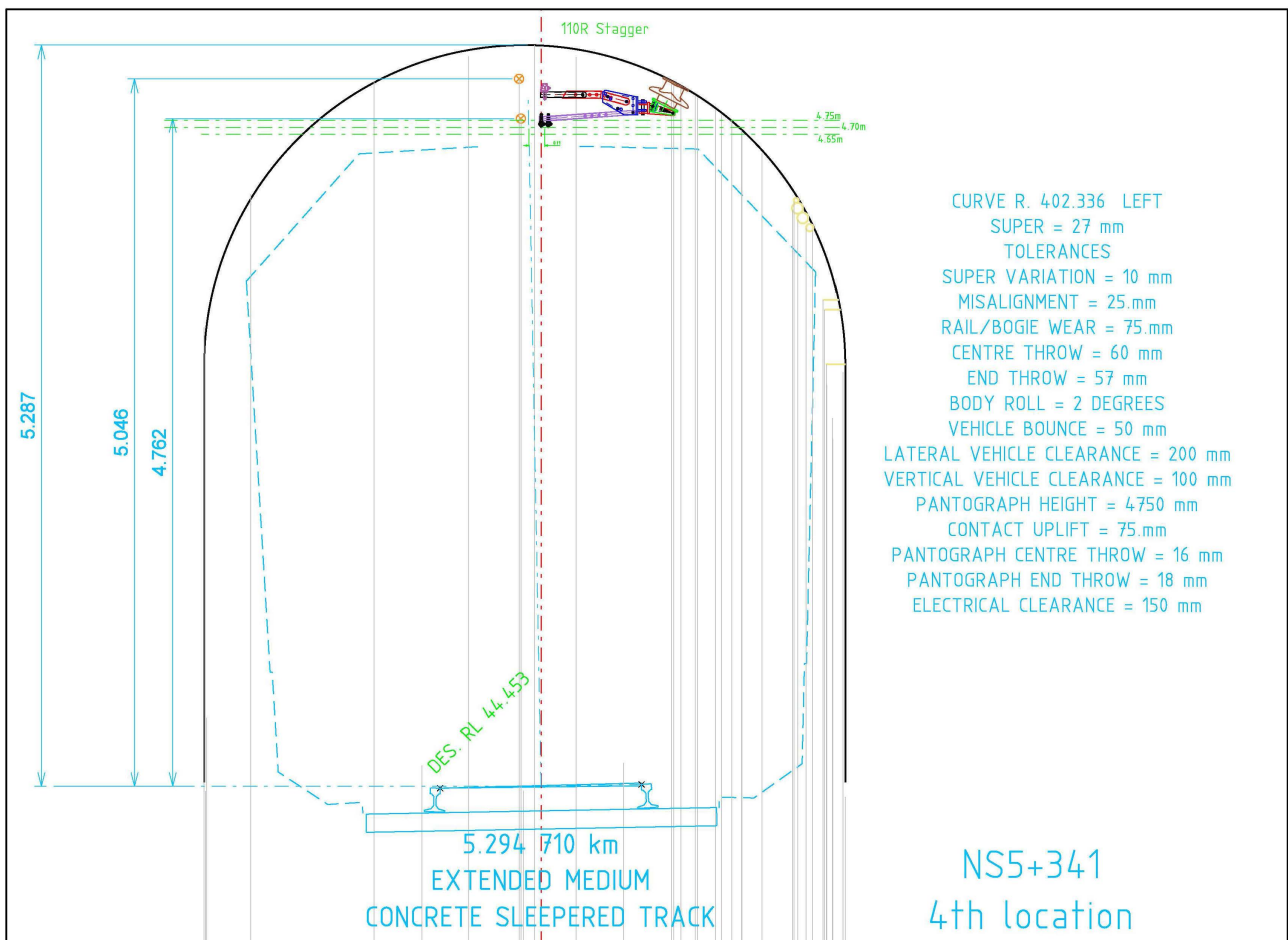
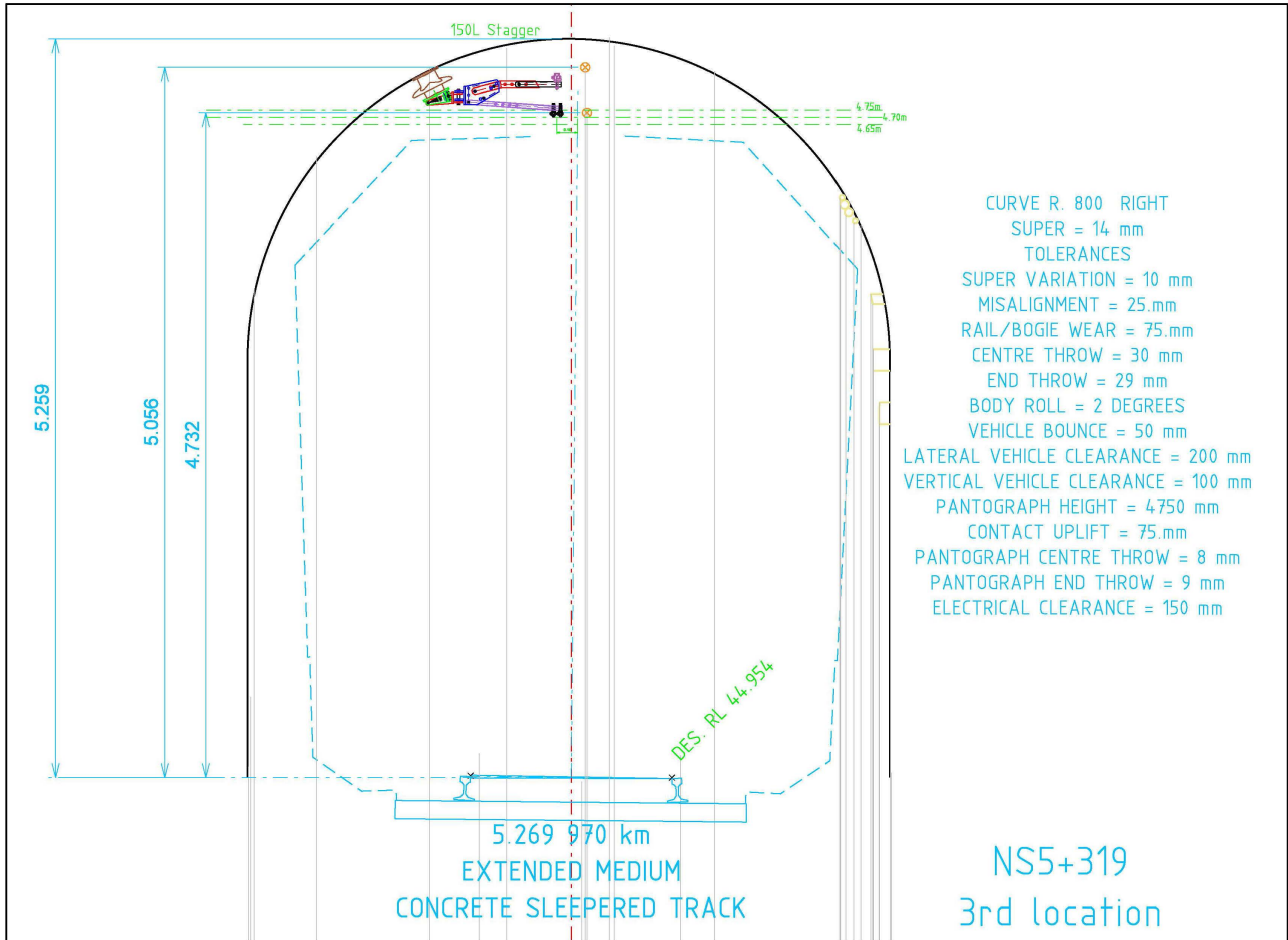

Reference material - for information only

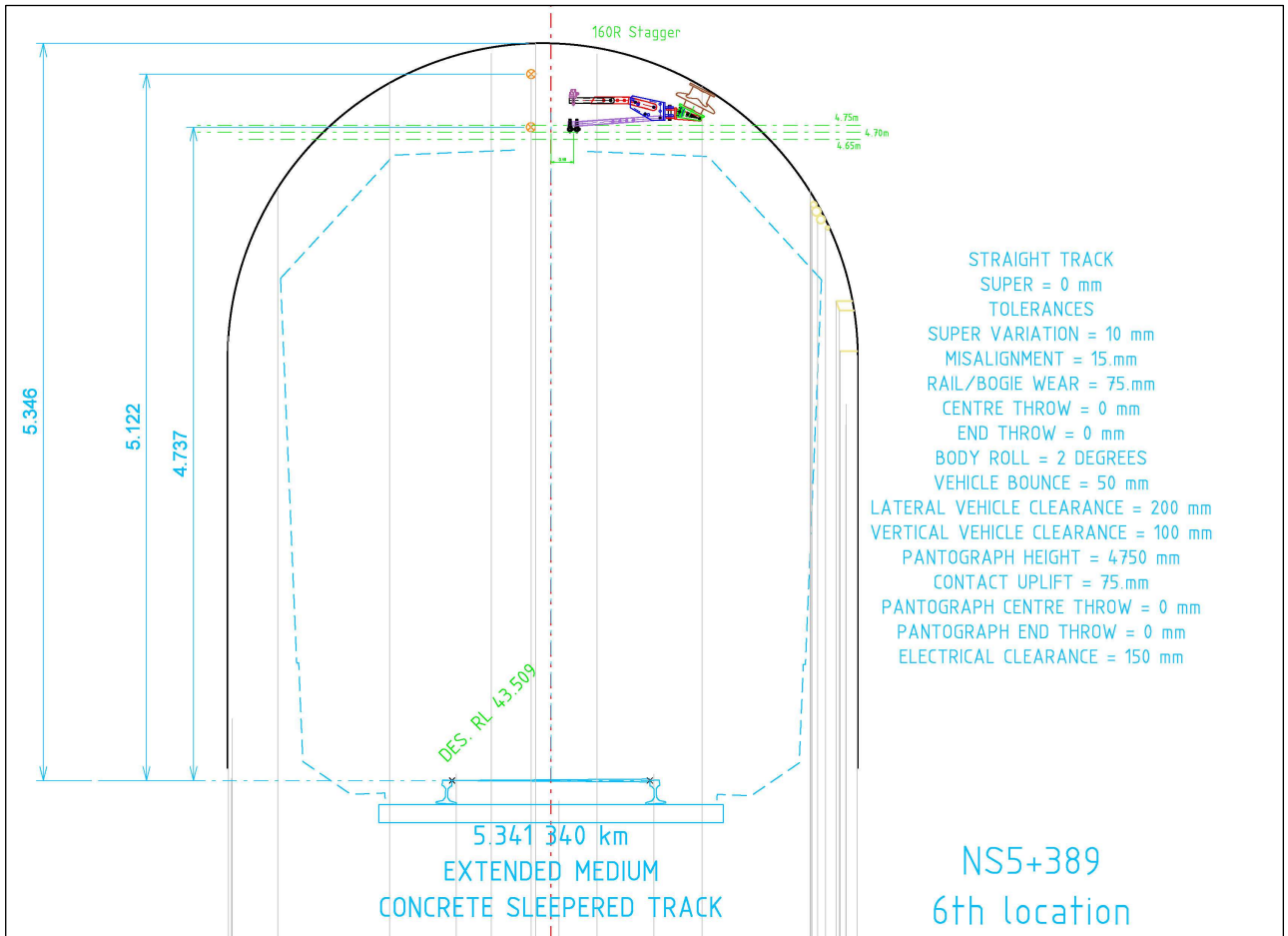
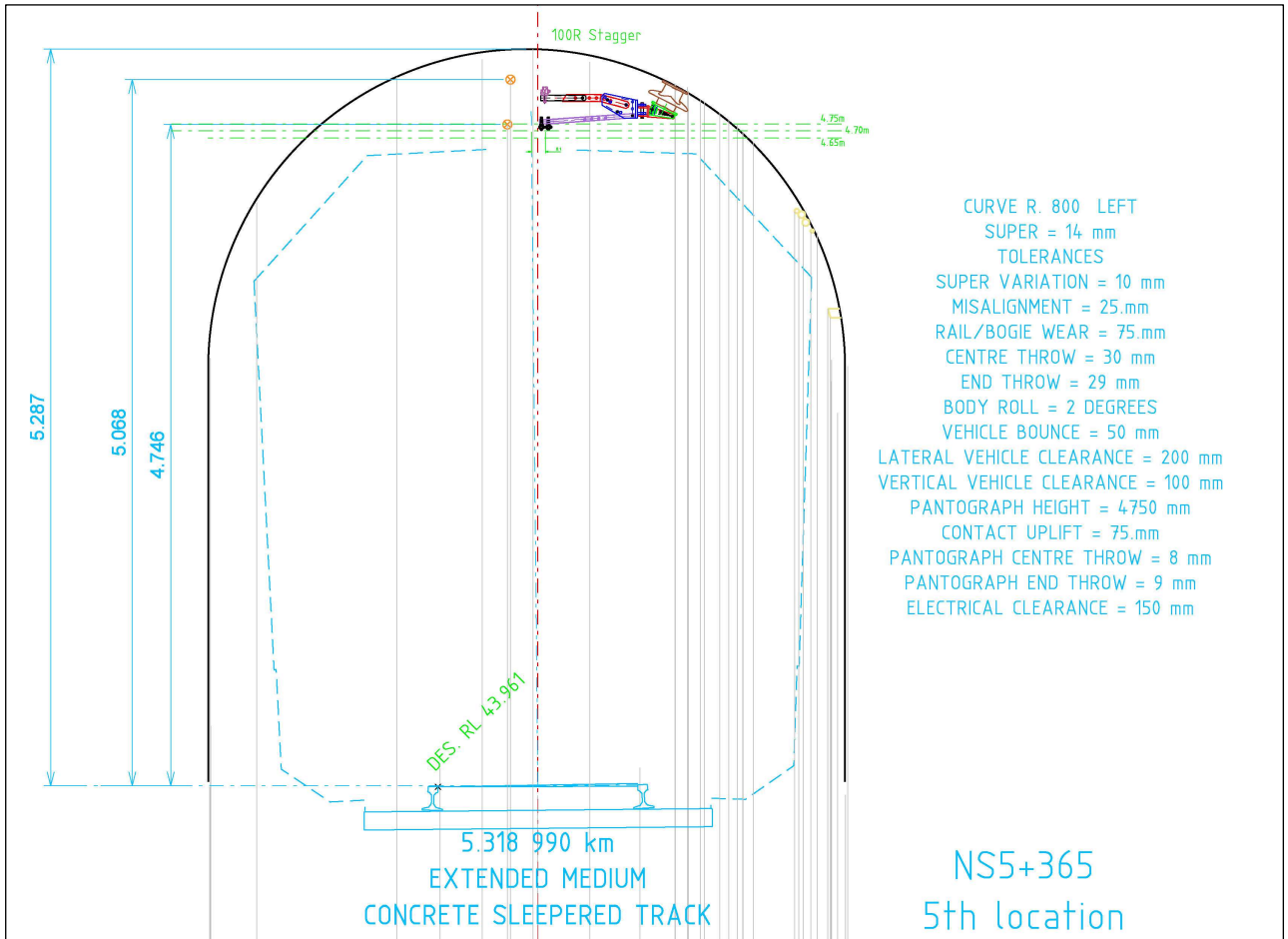

## **Appendix “C” - Civil Anchor Bolts for Tunnel Cantilever**

The Civil Design drawing showing the special anchoring arrangement used at North Sydney for the single track tunnels is shown in drawing CV 0518428 below.

It also shows details of the special insulation plate and ferrules needed to provide Secondary Insulation from 6 anchor bolts to the Mounting Plate.

Reference material - for information only



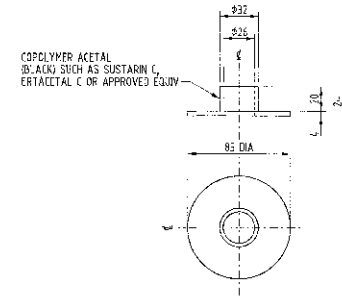
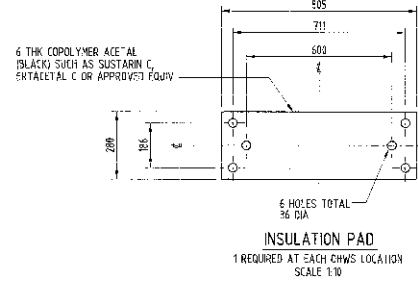
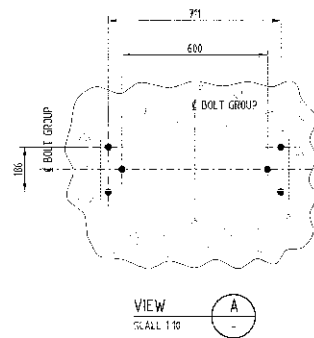
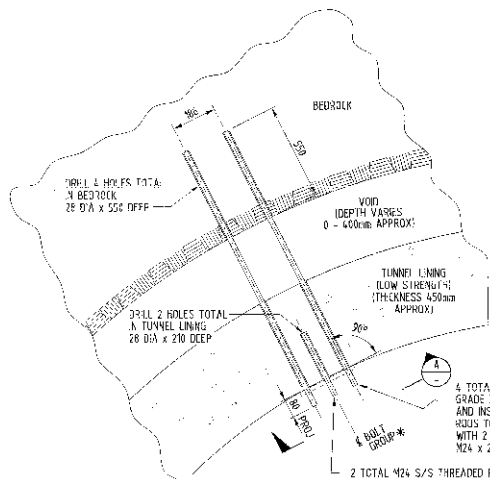

- \* ANCHOR BOLTS TO BE INSTALLED PARALLEL TO CENTRELINE OF BOLT GROUP. CENTRELINE TO BE PERPENDICULAR TO TUNNEL SURFACE.
- ANCHOR BOLTS TO BE INSTALLED TO EPOXY MANUFACTURER'S SPECIFICATIONS.
- ALL LONG BOLTS, 4 TOTAL, TO BE TEST LOADED TO 8KN ALLOW 1 HOUR MIN. CURING TIME.

TUNNEL CANTILEVER MARK 3 IS AN E. P. FITTING. REFER TO E. 0357172 FOR DETAILS.

**TUNNEL CANTILEVER MARK 3 - ANCHOR BOLTS**  
 DO NOT INSTALL ANCHOR BOLTS IF EVIDENCE OF WATER INGRESS EXISTS ON SURFACE OF TUNNEL LINING WITHIN PERIMETER OF BOLT GROUP. THE OHW LOCATION MAY NEED TO BE CHANGED - CONTACT CIVIL DESIGN.

1. MOUNTING PLATE TO BE PACKED WITH 60 DIA x 26 ID S/S WASHERS.
2. USE WASHERS IN COMBINATIONS OF 0.5mm & 2mm THICKNESS TO ENSURE EVEN PACKING ON ALL SIX ANCHOR BOLTS.
3. INSURE PLATE WHEN INSTALLED IS NOT IN CONTACT WITH CONCRETE SURFACE AT ANY POINT.
4. TUNNEL SURFACE IRREGULARITIES TO BE GRIND FLAT WHERE NECESSARY TO COMPLY WITH STEP 3.
5. PUT PACKERS ON 2 ANCHOR BOLTS FIRST, THEN PUT ON INSULATION PAD, MOUNTING PLATE, ETC.
6. NUTS ON CORNER BOLTS TO BE SNUG TIGHT. NUTS ON CENTRE BOLTS TO BE FINGER TIGHT PLUS HALF TURN ONLY.



TUNNEL CANTILEVER MARK 3 - PROCEDURE FOR INSTALLING MOUNTING PLATE

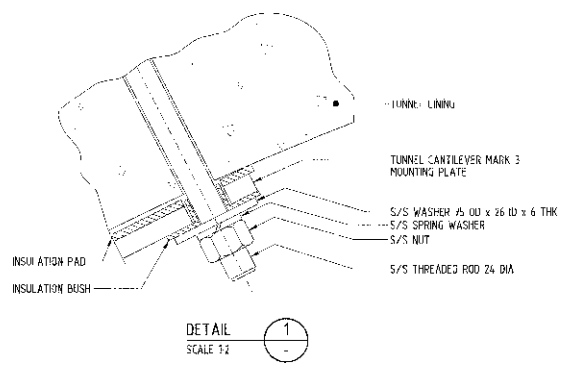

**NOTES**  
 GENERAL  
 1. DIMENSIONS SHALL NOT BE SCALED FROM THIS DRAWING.

**REFERENCES**

STRUCTURE DIAGRAMS UP TRACKS - SHT 3 OF 4	DRG CV 0518427
STRUCTURE DIAGRAMS UP TRACKS - SHT 4 OF 6	DRG CV 0518423
STRUCTURE DIAGRAMS DN TRACKS - SHT 3 OF 5	DRG CV 0518428
STRUCTURE DIAGRAMS DN TRACKS - SHT 4 OF 5	DRG CV 0518429
STRUCTURE DIAGRAMS DN TRACKS - SHT 5 OF 5	DRG CV 0518480

REV	DESCRIPTION	DATE	BY	CHECKED
1	ISSUED FOR ORIGINAL			

DESIGNED BY: *R. Corbin*  
 CHECKED BY: *S. Corbin*  
 APPROVED BY: *R. Liu*

DESIGNED BY: *R. Corbin*  
 CHECKED BY: *S. Corbin*  
 APPROVED BY: *R. Liu*

DESIGNED BY: *R. Corbin*  
 CHECKED BY: *S. Corbin*  
 APPROVED BY: *R. Liu*

**ARGYLE - WAVERTON**  
 NORTH SHORE LINE  
 SECTION 2 - NORTH SYDNEY - TUNNELS  
 DETAILS FOR TUNNEL CANTILEVER MARK 3  
 MISCELLANEOUS DETAILS

FILE NO.	SHEET 1 OF 1	DATE
STATUS: FOR CONSTRUCTION		

CV 0518429 | B

**WARNING SCANNED IMAGE**

## **Appendix “D” - OHW Design Drawings Calling Up Tunnel Cantilever**

The following OHW Design drawing show how the Tunnel Cantilevers are referenced for subsequent Construction :

- **Cross-Section**, showing site specific Tunnel Cantilever installation. Drawing EL 0518254.
- **OHW Layout**, showing the location of each Tunnel Cantilever. Drawing EL 0533544.
- **OHW Profile**, demonstrating suitable clearances are met. Drawing EL 0518911.

Reference material - for information only

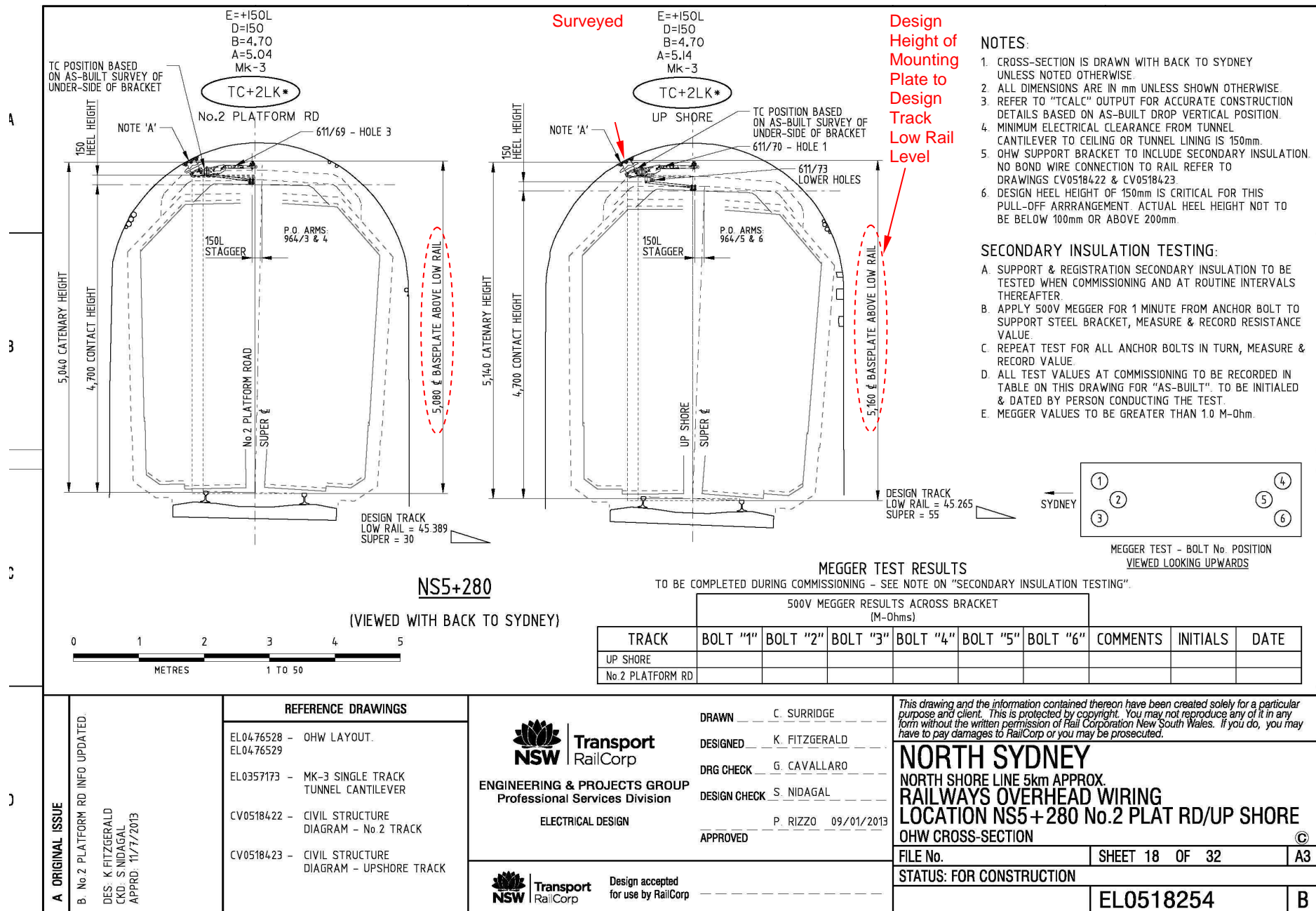

Figure 34 - Typical Cross-Section Drawing Showing Design Location of Mounting Bracket

File: Plotted RailCAD/Groups/Elec.dwg/Job: 2006/ARGYLE-WAVERTON\_Q/W\_E063007/drawings/EL\_0518254\_A1\_FC.DWG  
Plot Date & Time: 08-AUG-2013 09:41  
Plotted by: kfitzgerald

Reference material - for information only

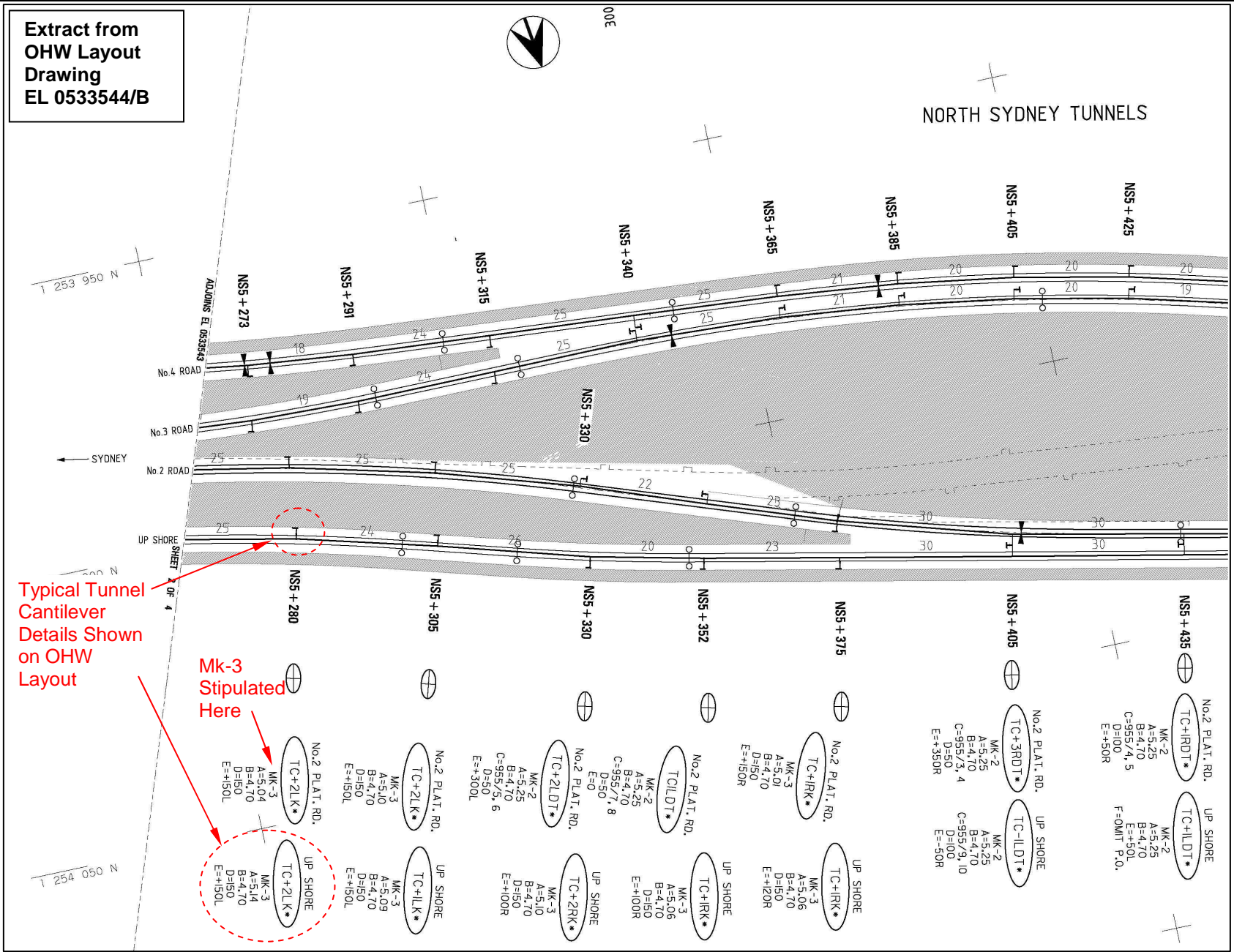

Figure 35 - Typical OHW Layout Referencing Mk-3 Tunnel Cantilevers

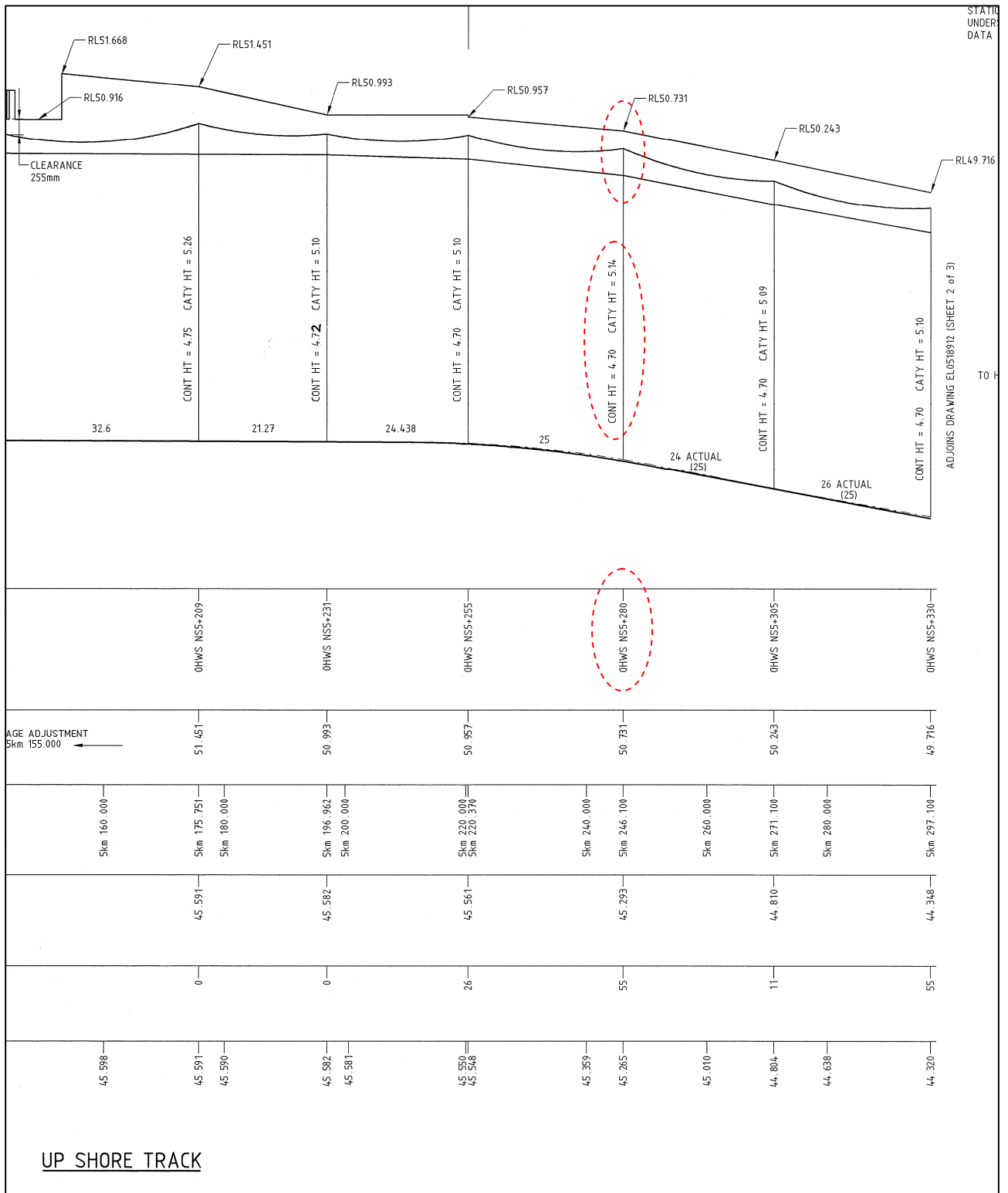

Figure 36 - Typical OHW Profile Drawing Confirming Clearances

**Appendix “E” - Maintenance Requirements Analysis**

The Maintenance Requirements Analysis (“MRA”) is shown on the following pages. This used to be called the Failure Modes, Effect & Criticality Analysis (“FMECA”).

Reference material - for information only



---

## Maintenance Requirements Analysis Report

---

### System Description

Equipment Code    Equipment Description

Function Description

Functional Failure Description

Failure Mode

Failure Effect

Criticality /  
Task Analysis

Proposed Task /  
Corrective Action

Optimal Interval/  
Scheduled Interval

Decision Basis

---

### Overhead Wiring

EP 08 11 79 00    Mark3 Tunnel Cantilever Arrangement

Optimal 0

due to

---

**System Description**

**Equipment Code Equipment Description**

**Function Description**

**Functional Failure Description**

Failure Mode

Failure Effect

Criticality /  
Task Analysis

Proposed Task /  
Corrective Action

Optimal Interval/  
Scheduled Interval

Decision Basis

**01) To support the catenary weight, radial and wind loads and register the contact radial and wind loads, while maintaining a minimum 150mm clearance from all structures.**

**A) Does not support the catenary weight, radial and wind loads and register the contact radial and wind loads, while maintaining a minimum 150mm clearance from all structures.**

32	Cantilever pivot thrust washer wear due to normal operational degradation.	Increased wear on support pivot plate and main support frame. No affect on system.	N N N N N N N N Y	Examine the cantilever pivot thrust washer for wear.	Optimal 0	Early detection of failed/missing washer will prevent degradation of the tensioning system.
30	Cantilever stainless steel pivot pin (120/15) breaks due to wear.	The cantilever can't maintain the required height & alignment of the OHW. OHW will foul the vehicle envelope. Damage to pantograph, train and OHW.	Y N N Y N N N N	Examine the cantilever stainless steel pivot pin for wear.	Optimal 0	
4	Cantilever stainless steel pivot pin (120/15) drops out due to detached split pin.	The cantilever can't maintain the required height & alignment of the OHW. OHW will foul the vehicle envelope. Damage to pantograph, train and OHW.	Y N N Y N Y	Examine the split pins of the cantilever stainless steel pivot pin for security. Replace worn or missing humpback (split) pin.	Optimal 0 Maint Crew (4 + vehicle) Hands On	
3	Cantilever stainless steel pivot pin (120/15) worn / bent due to normal operational pivoting under load.	Excessive movement at pivot point, consequential wear on other components. No affect on system.	N N N N N N N N Y	Examine the cantilever stainless steel pivot pin for excessive wear. Replace worn 19mm stainless steel pivot pin.	Optimal 0 Maint Crew (4 + vehicle) Hands On	Early detection of failed/missing pin will prevent degradation of the tensioning system.

**System Description**

Equipment Code		Equipment Description		Criticality / Task Analysis	Proposed Task / Corrective Action	Optimal Interval / Scheduled Interval	Decision Basis
Function Description		Functional Failure Description					
Failure Mode	Failure Effect						
29	Catenary clamp/swivel plate assembly (187 &61/6) binds due to worn thrust washer.	Catenary stranding due to fatigue. Catenary wire breakage would lead to secondary damage to other equipment on OHW tension length.	Y N N Y N Y	Examine thrust washer for excessive wear.	Optimal 0	Unlikely failure mode.	
13	Catenary clamp/swivel plate assembly (187 &61/6) breaks due to overload / stress.	The catenary will come adrift from the clamp and not be supported at that location. OHW will foul the vehicle envelope. Damage to pantograph, train and OHW.	Y N N Y N Y	Examine the catenary clamp and swivel plate for condition and security.  Repair / replace the suspension envelope as required.	Optimal 0  Hands On	Unlikely failure mode.	
22	Catenary clamp/swivel plate assembly (187 &61/6) loosens due to loose attachment clamp fastenings.	Catenary would slip through the catenary clamp due to longitudinal regulation movement. Wear and stranding of catenary in the area of the clamp would occur. Increased risk of catenary breaking.	N N N Y N N N N Y	Examine for loose catenary clamp nuts.  Re-secure the loose catenary suspension envelope. Repair stranded catenary.	Optimal 0  Hands On		
31	Catenary support external tube (611/68) bends / breaks due to corrosion.	The catenary will not be supported at that location. OHW will foul the vehicle envelope. Damage to pantograph, train and OHW.	Y N N Y N Y	Examine the catenary support external tube for signs of corrosion. Pay particular attention to the area inside of the main support frame.	Optimal 0		
34	Catenary support external tube (611/68) bends / breaks due to fractured weld.	The catenary will not be supported at that location. OHW will foul the vehicle envelope. Damage to pantograph, train and OHW.	Y N N Y N Y	Examine tube for signs of weld fracture/buckling/loss of galvanising.	Optimal 0		

**System Description**

**Equipment Code    Equipment Description**

**Function Description**

**Functional Failure Description**

	<b>Failure Mode</b>	<b>Failure Effect</b>	<b>Criticality / Task Analysis</b>	<b>Proposed Task / Corrective Action</b>	<b>Optimal Interval / Scheduled Interval</b>	<b>Decision Basis</b>
33	Catenary support external tube stainless steel pin breaks due to wear.	The catenary will not be supported at that location. OHW will foul the vehicle envelope.  Damage to pantograph, train and OHW.	Y N N Y N N N N	N Y N.S.M.	Optimal 0	Highly unlikely failure mode. No reported failures on similar tunnel cantilevers.
12	Catenary support internal tube (611/69) bends / breaks due to corrosion.	The catenary will not be supported at that location. OHW will foul the vehicle envelope.  Damage to pantograph, train and OHW.	Y N N Y N Y	Examine the catenary support internal tube for signs of corrosion. Pay particular attention to the inside of the tube.  Replace corroded catenary support inner tube.	Optimal 0  Hands On	Corrosion may originate on the interior of the tube. An alternative method of inspection may be required to increase the examination success.
15	Heel adjuster (611/73) bends / breaks due to corrosion.	The pull-off arm will swing down and foul the vehicle envelope.  Damage to pantograph, train and OHW.	Y N N Y N Y	Examine the heel adjuster (where installed) for corrosion.  Replace the corroded attachment inner tube.	Optimal 0  Hands On	
11	Insulator adjustment plate stainless steel pin (511/77) breaks due to wear.	The catenary will not be supported at that location. OHW will foul the vehicle envelope.  Damage to pantograph, train and OHW.	Y N N Y N N N N	N Y N.S.M.	Optimal 0	Highly unlikely failure mode. Designed for normal service loads.
21	Insulator mounting plate to tunnel lining breaks due to corrosion	The cantilever can't maintain the required height & alignment of the OHW. OHW will foul the vehicle envelope.  Damage to pantograph, train and OHW.	Y N N Y N Y	Examine the insulator's mounting plate for evidence of corrosion.  Replace insulator with cracked / damaged mounting arrangement.	Optimal 0  Hands On	

**System Description**

**Equipment Code    Equipment Description**

**Function Description**

**Functional Failure Description**

	Failure Mode	Failure Effect	Criticality / Task Analysis	Proposed Task / Corrective Action	Optimal Interval/ Scheduled Interval	Decision Basis
8	Main support frame (611/67) bends / breaks due to corrosion.	The catenary will not be supported at that location. OHW will foul the vehicle envelope.  Damage to pantograph, train and OHW.	Y N N Y N Y	Examine the main support frame for corrosion. Pay particular attention to the inner surfaces and welds.  Replace corroded cantilever jib.	Optimal 0  Hands On	These are hot dip galvanised and highly unlikely to corrode to failure.
36	Main support frame (611/67) bends / breaks due to fractured weld.	The catenary will not be supported at that location. OHW will foul the vehicle envelope.  Damage to pantograph, train and OHW.	Y N N Y N Y	Examine main support frame for signs of weld fracture/buckling/loss of galvanising.	Optimal 0	
57	Post type (epoxy) insulator (452/10) breaks due to threaded brass inserts pull out under load (over tightened during installation)	Load transferred to second insulator  No affect on system.	N N N N N N N N Y	Examine insulator for signs of cracks.	Optimal 0	
17	Pull-off arms (964/-) break due to corrosion.	The remainder of the pull-off arm will swing down and foul the vehicle envelope.  Damage to pantograph, train and OHW.	Y N N Y N Y	Examine contact registration arrangement's steel pull off arm for evidence of corrosion.  Replace corroded contact registration arrangement's steel pull off arm.	Optimal 0  Hands On	These are hot dip galvanised and highly unlikely to corrode
56	Pull-off arms (964/-) break due to wear.	The remainder of the pull-off arm will swing down and foul the vehicle envelope.  Damage to pantograph, train and OHW.	Y N N Y N Y	Examine for signs of wear at swivel clamp and main support frame.	Optimal 0	



**System Description**

**Equipment Code    Equipment Description**

**Function Description**

**Functional Failure Description**

	Failure Mode	Failure Effect	Criticality / Task Analysis	Proposed Task / Corrective Action	Optimal Interval/ Scheduled Interval	Decision Basis
1	Support pivot plate/insulator adjustment plate (611/66 & 611/65) breaks due to corrosion	The cantilever can't maintain the required height & alignment of the OHW. OHW will foul the vehicle envelope.  Damage to pantograph, train and OHW.	Y N N Y N Y	Examine the support pivot plate/insulator adjustment plate for signs of corrosion.  Replace corroded pivot bracket.	Optimal 0  Hands On	
35	Support pivot plate/insulator adjustment plate (611/66 & 611/65) breaks due to fractured weld.	The catenary will not be supported at that location. OHW will foul the vehicle envelope.  Damage to pantograph, train and OHW.	Y N N Y N Y	Examine support pivot plate for signs of weld fracture/buckling/loss of galvanising.	Optimal 0	Weld designed to suit loading on component.

**System Description**

**Equipment Code    Equipment Description**

**Function Description**

**Functional Failure Description**

Failure Mode

Failure Effect

Criticality /  
Task Analysis

Proposed Task /  
Corrective Action

Optimal Interval/  
Scheduled Interval

Decision Basis

**02) To maintain the specified electrical isolation from the tunnel, bridge and structures.**

**A) Does not maintain the specified electrical isolation from the tunnel, bridge and structures.**

55	Post type insulator (452/10) breaks due to threaded brass inserts pull out under load (over tightened during installation)	Load transferred to second insulator No affect on system.	N N N N N N N N N Y	Examine insulator for signs of cracks.	Optimal 0	
39	Post type insulator (452/10) chipped / cracked due to vandalism.	Risk of flashover due to lightning strike and permanent insulation failure. Supply would be unable to be restored. Line blockage.	N N N Y N Y	Examine the post type insulator for cracks and chips. Replace cracked or chipped post type insulator.	Optimal 0 Patrol	Rare failure mode on epoxy insulators. Unlikely failure mode due to limited access in tunnel.
37	Post type insulator (452/10) flashed over due to lightning strike.	Risk of insulation failure. Supply would be unable to be restored. Line blockage.	N N N Y N Y	Examine the post type insulator for lightning damage. Replace damaged post type insulator.	Optimal 0 Patrol	Is done as part of OHW patrol.
38	Post type insulator (452/10) leaks excessive current due to contamination of surface (rain cannot wash insulators clean).	Insulation failure. Extremely small possibility of leaky insulators causing current to enter tunnel lining. Where installed secondary insulation will further reduce possibility of leakage current. No affect on system.	N N N N N N N N N Y	Examine the post type insulator for surface contamination. Clean post type insulator as required.	Optimal 0 Hands On	Based on installation in tunnel with non conductive lining. Bonding may be required in other cases.

**System Description**

**Equipment Code    Equipment Description**

**Function Description**

**Functional Failure Description**

Failure Mode

Failure Effect

Criticality /  
Task Analysis

Proposed Task /  
Corrective Action

Optimal Interval/  
Scheduled Interval

Decision Basis

**03) To allow the overhead wiring conductors to move in the along track direction to maintain a constant tension during changes in conductor temperature.**

**A) Does not allow the overhead wiring conductors to move in the along track direction to maintain a constant tension during changes in conductor temperature.**

Main support frame (611/67)  
binds  
due to

Optimal 0

58 Main support frame (611/67)  
binds  
due to deformation of clevis or  
pin.

Catenary would slip through the catenary clamp due to longitudinal  
regulation movement.

N N N N N N N N    N N Y N.S.M.

Optimal 0

Possibility of stranding the catenary due to fatigue during temperature  
induced movement of the OHW. Increased risk of eventual breakage.

Unlikely failure mode,  
would require external  
influence to cause damage  
to clevis.

**System Description**

**Equipment Code Equipment Description**

**Function Description**

**Functional Failure Description**

Failure Mode

Failure Effect

Criticality /  
Task Analysis

Proposed Task /  
Corrective Action

Optimal Interval/  
Scheduled Interval

Decision Basis

**04) To position the catenary and contact wires at designed (required) height and stagger**

**A) Does not position the catenary and contact wires at designed (required) height and stagger**

54	Catenary support external tube stainless steel pin drops out due to missing split pin.	The catenary will not be supported at that location. OHW will foul the vehicle envelope.  Damage to pantograph, train and OHW.	Y N N Y N Y	Examine the pin for presence of both humpback split pins.	Optimal 0	
50	Contact clamp assembly (61/2) attachment to arm detaches due to incorrect installation of split pin.	The required contact stagger will not be maintained at that location.  Damage to pantograph, train and OHW.	Y N N Y N Y	Examine the split pin of the contact clamp assembly's stainless steel pivot pin for security.  Replace missing or worn split pin.	Optimal 0  Hands On	Poor installation should be addressed as a QA or commissioning issue.
51	Contact clamp assembly (61/2) attachment to contact wire breaks due to overload / stress.	The required contact stagger will not be maintained at that location.  Damage to pantograph, train and OHW.	Y N N Y N Y	Examine the contact clamp assembly for cracking and evidence of overloading.  Replace cracked / broken contact contact clamp assembly.	Optimal 0  Hands On	
52	Contact clamp assembly (61/2) attachment to contact wire comes adrift due to loose fastenings (operational degradation).	The required contact stagger will not be maintained at that location.  Damage to pantograph, train and OHW.	Y N N Y N Y	Examine the contact clamp for secure attachment to the contact wire. Pay particular attention for evidence of slippage.  Resecure or replace loose contact clamp assembly.	Optimal 0  Hands On	

**System Description**

**Equipment Code    Equipment Description**

**Function Description**

**Functional Failure Description**

	Failure Mode	Failure Effect	Criticality / Task Analysis	Proposed Task / Corrective Action	Optimal Interval / Scheduled Interval	Decision Basis
49	Pull-off arm bends due to impact from pantograph	The height and stagger of the OHW will be out of adjustment. Damage to pantograph, train and OHW. The extent of damage would be dependent on how bent the pull-off arm is.	Y N N Y N Y	Examine pull-off arm for deformation and other evidence of impact. (patrol & hands on)  Replace deformed pull-off arm. Check OHW stagger.	Optimal 0  Patrol	This failure mode would only occur in conjunction with a grossly out of adjustment stagger.
59	Pull-off arm breaks due to wear / corrosion.	Pull-off arrangement fouls vehicle envelope. Possible damage to rail vehicle.	Y N N Y N Y	Examine pulloff arm for signs of excessive wear at the pivot pin.	Optimal 0	
53	Pull-off arm 16mm stainless steel pivot /attachment pin drops out due to ineffective split pin.	The pull-off arm may swing down and foul the vehicle envelope. Damage to pantograph, train and OHW.	Y N N Y N Y	Examine the split pin of the pull-off arm's pivot / attachment pin for security.  Replace worn or missing humpback (split) pin.	Optimal 0  Hands On	



**Appendix “F” - Service Schedules**

To be provided.

Reference material - for information only

## **Appendix “G” - Technical Maintenance Plan**

To be provided.

Reference material - for information only

## Appendix "H" - OHW Conductor Movement / Temperature Chart

DISTANCE FROM FIXED ANCHOR "D" (m)	TEMPERATURE (°C)													
	-5	0	5	10	15	20	25	30	35	40	45	50	55	60
	OFFSET "X" (mm)													
50	-30	-20	-20	-10	-10	0	0	0	10	10	20	20	30	30
100	-50	-40	-30	-30	-20	-10	0	10	20	30	30	40	50	60
150	-80	-60	-50	-40	-30	-10	0	10	30	40	50	60	80	90
200	-100	-90	-70	-50	-30	-20	0	20	30	50	70	90	100	120
250	-130	-110	-90	-60	-40	-20	0	20	40	60	90	110	130	150
300	-150	-130	-100	-80	-50	-30	0	30	50	80	100	130	150	180
350	-180	-150	-120	-90	-60	-30	0	30	60	90	120	150	180	210
400	-200	-170	-140	-100	-70	-30	0	30	70	100	140	170	200	240
450	-230	-190	-150	-110	-80	-40	0	40	80	110	150	190	230	270
500	-260	-210	-170	-130	-90	-40	0	40	90	130	170	210	260	300

DESIGN TEMPERATURE (°C):	25
ALPHA (PER °C):	17 x 10 <sup>-6</sup>

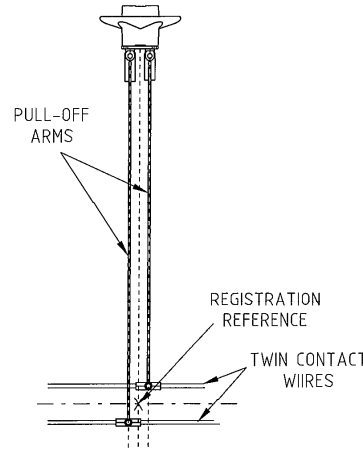

PLAN VIEW (N.T.S)

**REGISTRATION REFERENCE FOR TWIN CONTACT**  
(SEE NOTE 4)

**NOTES:**

- THIS CHART IS APPLICABLE TO REGULATED OHW ONLY. IT SHOWS THE AMOUNT OF CONTACT WIRE ELONGATION ("X") WITH TEMPERATURE, AS A FUNCTION OF DISTANCE ("D") FROM THE FIXED ANCHOR OR FIXED MID-POINT. NUMBERS SHOWN ARE ROUNDED TO THE NEAREST 10mm.
- AT DESIGN TEMPERATURE THE CANTILEVER SUPPORT & PULL-OFF ARM REGISTRATION ARE TO BE AT RIGHT ANGLES ("NORMAL") TO THE CONTACT WIRE, REGARDLESS OF DISTANCE TO FIXED ANCHOR. AT OTHER TEMPERATURES APPLY THE OFFSET "X" AS SHOWN IN TABLE.
- SIGN CONVENTION: A POSITIVE "X" VALUE PLACES THE REGISTRATION CONNECTION FURTHER AWAY FROM THE FIXED ANCHOR.
- IN THE CASE OF TWIN CONTACT, THE REGISTRATION REFERENCE IS TO THE MEAN POSITION OF THE PULL-OFF ARMS - SEE "REGISTRATION REFERENCE FOR TWIN CONTACT".
- THIS CHART IS TO BE USED BY CONSTRUCTION STAFF TO SET THE CORRECT POSITION OF THE PULL-OFF ARM ATTACHMENT ON THE CONTACT WIRE, WHICH MUST BE RELATED TO THE TEMPERATURE AND SPECIFIC DISTANCE FROM THE FIXED ANCHOR. CANTILEVER SUPPORT IS TO BE LOCATED DIRECTLY ABOVE THIS CONTACT REGISTRATION POINT.
- THIS CHART IS ALSO TO BE USED BY MAINTENANCE STAFF TO PERIODICALLY CHECK AND/OR RESET THE ARM POSITION AND/OR THE CANTILEVER SUPPORT LOCATION.
- TYPICAL MAXIMUM DISTANCE OF OHW FROM FIXED ANCHOR OR FIXED MID-POINT IS 1,000m.

#SEE NOTE 7

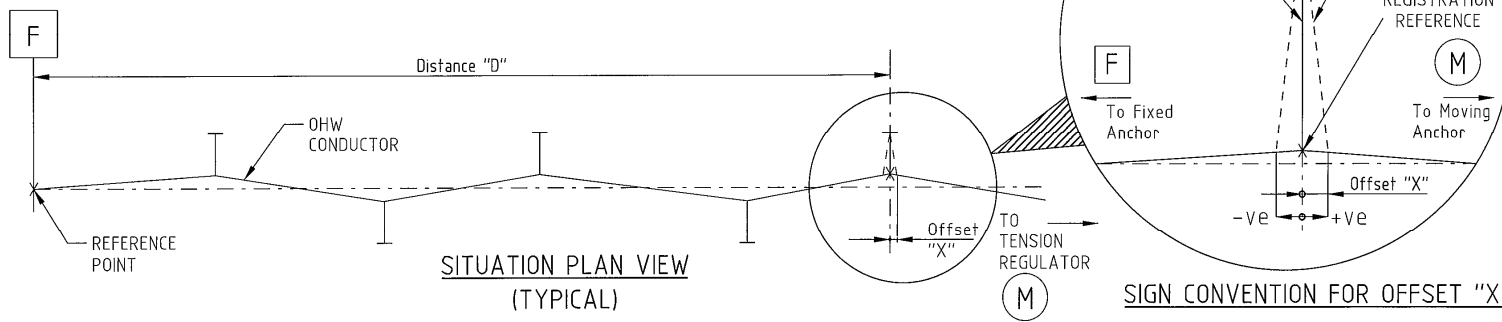

**LEGEND**

F LOCATION OF FIXED ANCHOR OR FIXED MID-POINT ANCHOR

M MOVING END (TENSION REGULATOR)

MAST (TYPICAL)